



CATALOGUE

 (+84) 0903.000.231

 www.marico.com.vn

 info@marico.com.vn

 183C/5P Ton That Thuyet Street, Ward 4, District 4, HCMC

 (+84) 0903 000 231

 www.marico.com.vn

Up to now, MARICO has shown its capability to satisfy the most exacting demands of both local and international fleets

- 01** / About us
- 04** / Register
- 08** / Flag Authority
- 09** / Maker

- 15** / Business partner
- 17** / Customer
- 20** / Our Services

- 25** / Product
- 28** / Lifesaving equipments
- 112** / Fire fighting equipments
- 130** / Other devices



HEADQUARTERS:
183C/5P Ton That Thuyet Street, Ward 4, District 4, HCMC

HoChiMinh Office
389 Dao Tri Street, Phu Thuan Ward, District 7, HCMC

Kien Giang Branch
101, Quarter 4, Vinh Thong Ward, Rach Gia City, Kien Giang

Vung Tau Branch
National Route 51, Tan Hai, Phu My, Ba Ria – Vung Tau

Hai Phong Branch
KM2 +200 Dinh Vu, Dong Hai II, Hai An, Hai Phong

Ha Tinh Branch
515 Quang Trung Street, Ky Phuong Ward, Ky Anh Town, Ha Tinh Province

Quang Ngai Branch
239 National Route 1A, Binh Chanh Village, Binh Son District, Quang Ngai Province

MARICO

"Up to now, MARICO has shown its capability to satisfy the most exacting demands of both local and international fleets."

MA RI MARITIME TRADING & SERVICES COMPANY

(MARICO) was established in 2005, which is located in HoChiMinh City, Vietnam, is one of the earliest Vietnamese companies in the service of inspection and maintenance of life-saving and fire-fighting equipment. To guarantee the safety of human life at sea, we have a technical staff that complies with high standards and technologica criteria.

OUR MISSION

Create a safe and prosperous world by providing customers with secure products and services that protect people and their property above expectations

OUR VISION

- Become the premier, reputable supplier of equipment and services for marine safety equipment in Vietnam and Southeast Asia .
- 100% of the management and employees are dedicated and skilled.



Over nearly the past decade, MARICO has expanded and opened more service stations nationwide. Six service stations (Ho Chi Minh, Hai Phong, Vung Tau, Ha Tinh, Kien Giang and Quang Ngai) with more than 100 workers, engineers and a system of modern equipment born our company.

CORPORATE CULTURE

MARICO brings together the most capable Vietnamese and international professionals who possess intellect and discipline, talent and determination, patriotism and ethnic pride, charity, good intentions and intense work ethics.

Each MARICO employee must be proactive, eager to learn, constantly strive for self-improvement and internalize the Company's culture and its six core values as a guideline for his or her actions.

Innovation must be constant and continuous to accomplish the goals of "Best People - Best Products & Services - Best Life - Best Society". This non-stop effort is to ensure sustained development of the Company and bring future generations a better life.

At MARICO, each employee considers the Group a second home, a place to engage and spend the majority of each day to live and work. In any role and any position, we are proud to be a member of the MARICO family.

STRATEGIC HUMAN RESOURCE

MARICO considers human capital a core element and most valuable asset of any successful organization. The Company has built a lean staff full of both virtue and talent. Our objective is to attract and welcome any candidate interested in a dynamic work environment that emphasises speed, creativity and efficiency-a place where each individual can maximise development of their capabilities and professional expertise.

MARICO puts special emphasis on the development its people through regular and effective training designed to enhance their knowledge and professional qualifications. Better, more qualified employees have the added benefit of becoming worthy representatives of MARICO under all circumstances.



BUSSINESS PARTNERS



CUSTOMERS





PRODUCTS

“Creating products and services of optimal quality, bringing satisfaction to customers at the highest level.”



LIFESAVING EQUIPMENTS

Free Fall Lifeboat

- Capacity: 26 persons
 - LxBxD (m): 5.90 x 2.75 x 1.06
 - Weight boat: 3,270 Kg
 - Full weight: 5,415 Kg
 - Type: Fireproof
 - Engine: Diesel
- Capacity: 31 persons
 - LxBxD (m): 6.70 x 2.75 x 0.90
 - Weight boat: 3,985 Kg
 - Full weight: 6,626 Kg
 - Type: Fireproof
 - Engine: Diesel



Totally Enclosed Lifeboats

- Capacity: 26 persons
 - LxBxD (m): 5.00 x 2.20 x 1.10
 - Weight boat: 2,330 Kg
 - Full weight: 4,310 Kg
 - Type: Common
 - Engine: Diesel
 - Hook distance: 4.60 m
- Capacity: 45 persons
 - LxBxD (m): 5.90 x 2.78 x 1.15
 - Weight boat: 3,050 Kg
 - Full weight: 6,762.5 Kg
 - Type: Fireproof
 - Engine: Diesel
 - Hook distance: 5.45 m

- Capacity: 36 persons
- LxBxD (m): 6.50 x 2.32 x 1.15
- Weight boat: 2,940 Kg
- Full weight: 5,920 Kg
- Type: Fireproof
- Engine: Diesel
- Hook distance: 6.1 m



Rescue Boats

- Capacity: 6 persons
- LxBxD (m): 4.30 x 1.86 x 0.780
- Weight boat: 605 Kg
- Full weight: 1,100 Kg
- Type: Fireproof
- Engine: gasoline
- Hook distance: ≥ 6 Knots



- Capacity: 6 persons
- LxBxD (m): 4.58 x 1.88 x 0.85
- Weight boat: 990 Kg
- Full weight: 1,485 Kg
- Type: Fireproof
- Engine: Diesel
- Speed: ≥ 6 Knots



LIFERAFT

Throw-over Type Inflatable Liferaft

Capacity	Size (LxBxD)	Weight A Pack (Kg)	Weight B Pack (Kg)	Container Size
6	2,175 x 2,175 x 1,250 mm	≤ 85	≤ 70	Ø 610 x 1100
10	2,730 x 2,730 x 1,400 mm	≤ 105	≤ 80	Ø 685 x 1150
15	3,380 x 3,380 x 1,500 mm	≤ 135	≤ 100	Ø 700 x 1300
16	3,380 x 3,380 x 1,500 mm	≤ 137	≤ 100	Ø 700 x 1300
20	4,350 x 3,050 x 1,600 mm	≤ 170	≤ 125	Ø 730 x 1550
25	4,835 x 3,325 x 1,700 mm	≤ 200	≤ 145	Ø 730 x 1550



Capacity	Size (LxBxD)	Weight A Pack (Kg)	Weight B Pack (Kg)	Container Size pack A (cm)	Container Size pack B (cm)
6	2,175 x 2,175 x 1,250 mm	≤ 90	≤ 80	110 x 61 x 58	110 x 61 x 58
8	3,245 x 2,295 x 1,300 mm	≤ 110	≤ 90	110 x 64 x 64	110 x 61 x 58
10	3,245 x 2,295 x 1,300 mm	≤ 110	≤ 90	110 x 64 x 64	110 x 61 x 58
12	3,555 x 2,455 x 1,330 mm	≤ 125	≤ 100	115 x 71 x 71	110 x 64 x 64
15	4,110 x 2,700 x 1,350 mm	≤ 140	≤ 110	125 x 71 x 71	115 x 71 x 71
16	4,110 x 2,700 x 1,350 mm	≤ 150	≤ 110	125 x 71 x 71	115 x 71 x 71
20	4,585 x 3,000 x 1,570 mm	≤ 175	≤ 135	135 x 71 x 71	125 x 71 x 71
25	5,075 x 3,325 x 1,700 mm	≤ 185	≤ 140	140 x 75 x 75	135 x 71 x 71
30	5,580 x 2,960 x 1,750 mm	≤ 215	≤ 160	146 x 75 x 75	140 x 75 x 75
32	6,200 x 3,370 x 1,800 mm	≤ 235	≤ 180	152 x 79 x 79	146 x 75 x 75
35	6,200 x 3,370 x 1,800 mm	≤ 240	≤ 180	152 x 79 x 79	146 x 75 x 75



Davit-launched Inflatable Liferaft



Capacity	Size (LxW)	Weight (kg)
6	2,104 x 2,104 mm	78
8	2,390 x 2,390 mm	90
10	2,694 x 2,694 mm	102
12	2,924 x 2,924 mm	120
15	3,238 x 3,238 mm	130
16	3,330 x 3,330 mm	140
20	4,304 x 2,974 mm	160
25	4,894 x 3,194 mm	185
30	5,384 x 3,414 mm	205
35	5,899 x 3,568 mm	230



Capacity	Size (LxW)	Weight (kg)
6	2,160 x 2,160 mm	75
10	2,730 x 2,730 mm	94
15	3,405 x 3,405 mm	132
16	3,405 x 3,405 mm	132
20	4,280 x 3,080 mm	155
25	4,700 x 3,450 mm	140

Capacity	Size (LxW)	Weight (kg)
10	3,575 x 3,400 mm	168
16	3,575 x 3,400 mm	168
20	4,020 x 3,825 mm	180
25	4,530 x 3,730 mm	210



Lifesaving Apparatus

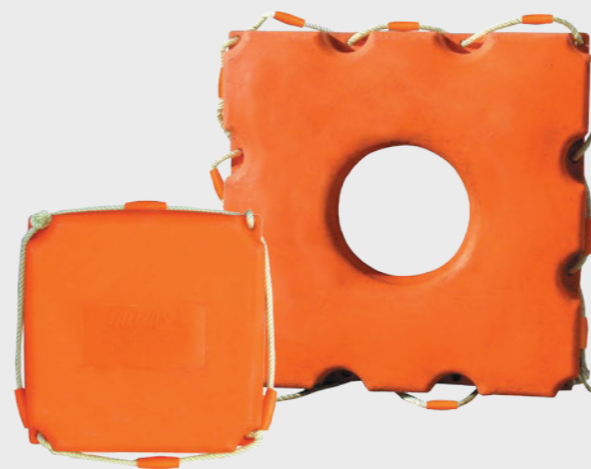

LALIZAS Foam Lifejacket Advanced, SOLAS/MED

- For use on sail or motor boats
- Outer cover made of high strength polyethylene with an inner polystyrene filling
- Complete with all-round rope lifeline
- Available in 4, 8 and 12 person models
- High visibility orange
- Approved to EEP. Approval number: 4232/46/00

Code	70131	70133	70135
Persons	4	8	12
Volume (lt)	80	151	252
Weight (kg)	5	11	18
A (cm)	55	76	100
B (cm)	55	76	100
C (cm)	25	25	25

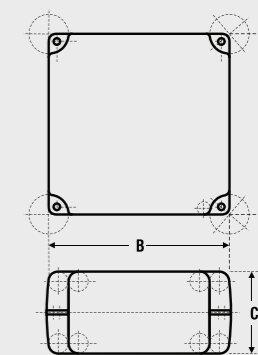

Capacity	Size (LxWxH)	Weight A Pack (Kg)	Weight B Pack (Kg)	Container Size (cm)
10	2,970 x 2,970 x 1,750 mm	< 140	< 120	135 x 71 x 71
12	2,970 x 2,970 x 1,750 mm	<140	< 120	135 x 71 x 71
15	3,800 x 3,380 x 1,850 mm	< 160	< 130	135 x 71 x 71
16	3,800 x 3,380 x 1,850 mm	< 160	< 130	135 x 71 x 71
20	3,760 x 3,760 x 2,150 mm	< 190	< 150	140 x 75 x 75
25	4,280 x 4,280 x 2,280 mm	< 220	< 185	146 x 75 x 75
30	5,470 x 5,470 x 3,570 mm	< 285	< 225	150 x 85 x 85
32	5,470 x 5,470 x 3,570 mm	< 290	< 225	150 x 85 x 85
35	5,885 x 5,885 x 3,785 mm	< 315	< 245	188 x 83 x 77
37	5,885 x 5,885 x 3,785 mm	< 320	< 245	188 x 83 x 77



LALIZAS Lifesaving Apparatus "Cushion Type"

- For use on sail or motor boats
- Made of a durable nylon outer shell and inner layers of polyethylene
- Complete with all round rope (lifeline)
- Lightweight
- Can be used as a seat cushion
- Available in 3,4 and 6 person models
- High visibility orange
- Approved to EEP. Approval number: 4232/24/01

Code	70270	70271	70272
Persons	3	4	6
A (cm)	40	52	46
B (cm)	50	47	70
C (cm)	29	25	36

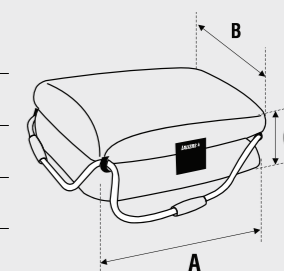

- Origin: China
- Outer material: Composite PVC 1.5 - 3.2 mm
- Inner material: Polyurethane - Foam
- Capacity: 6 - 8 - 10 - 12
- Approval: CCS
- Color: orange, There are 4 reflective panels around
- Floating volume: $\geq 196 \text{ dm}^3$
- Buoyancy: $\geq 170 \text{ kg}$
- 10 people clinging around and 01 60kg person placed on the net
- Size: L $1,500 \pm 15 \text{ mm}$, W $980 \pm 10 \text{ mm}$, D $260 \pm 5 \text{ mm}$
- Average weight: $24 \pm 2 \text{ kg}$
- Polyester outer strap 12mm, rubber grip 30mm, length 200mm
- The mesh is knit inside with polyester rope, the smallest is 6mm

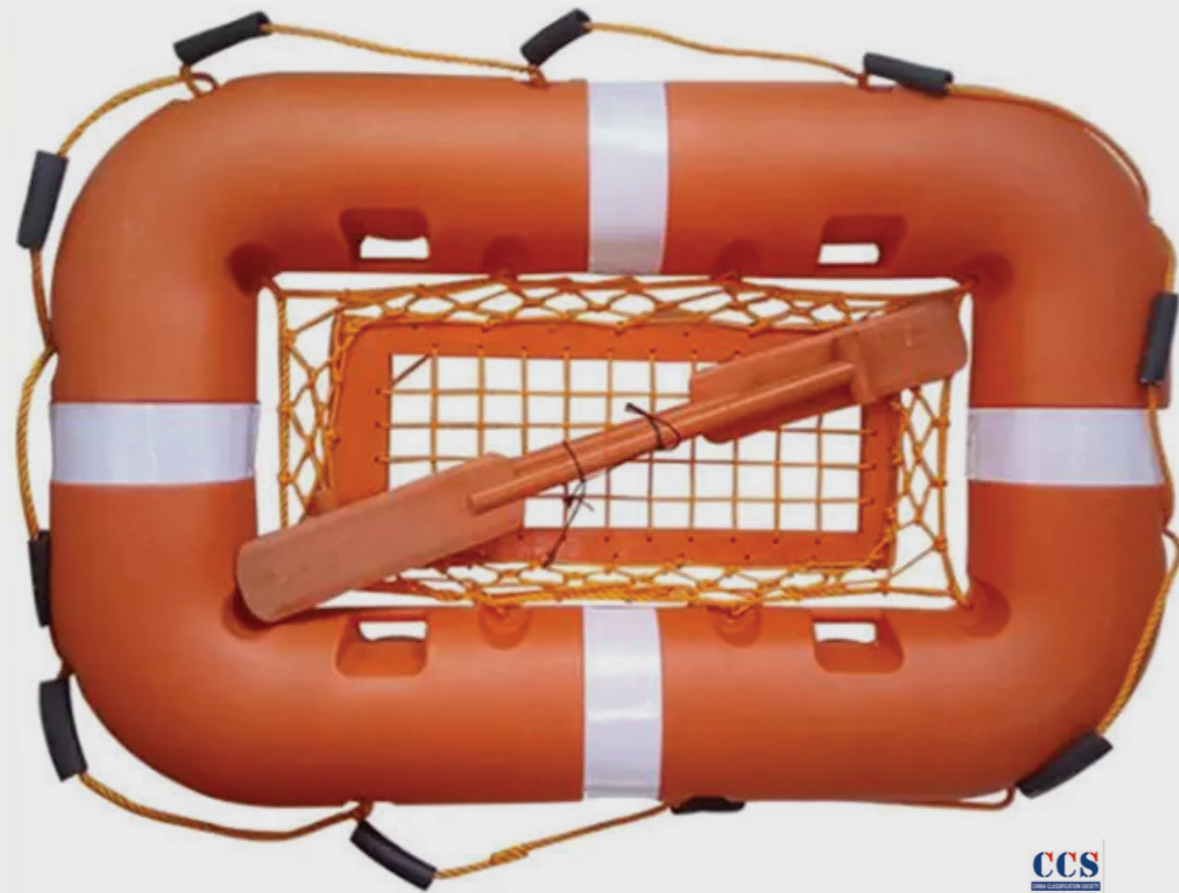

CCS
中国船级社



Lifebouy rings



LALIZAS Lifebuoy Ring, with SOLAS Retroreflective Tape

Code	70090	70110	700901	701101
Approval	SOLAS/MED		USCG SOLAS	
Weight (kg)	2.5	4	2.5	4
Drop Height (m)	80		80	

- Ext. Diameter: Ø 720 mm ± 10 mm
- Int. Diameter: Ø 440 mm ± 10 mm
- Height: 105 mm ± 10 mm



LALIZAS Lifebuoy Ring, No 45 with Rope

- Ext. Diam.: 420mm
- Int. Diam.: 210mm

Code | 63219



EVAL Lifebuoy SOLAS 74, L.S.A Code M.E.D., 2014/90/EU IMO MSC 81(70)

Code	00559	00558
Approval	SOLAS 74	
Weight (kg)	2.5	4
Drop Height (m)	80	

- Ext. Diameter: Ø 600 mm (2.5kg)
Ø 750 mm (4kg)
- Int. Diameter: Ø 400 mm (2.5kg)
Ø 436 mm (4kg)



EVAL Lifebuoy Ring

- Ext. Diam.: 450 mm
- Int. Diam.: 235 mm

Code | 00539

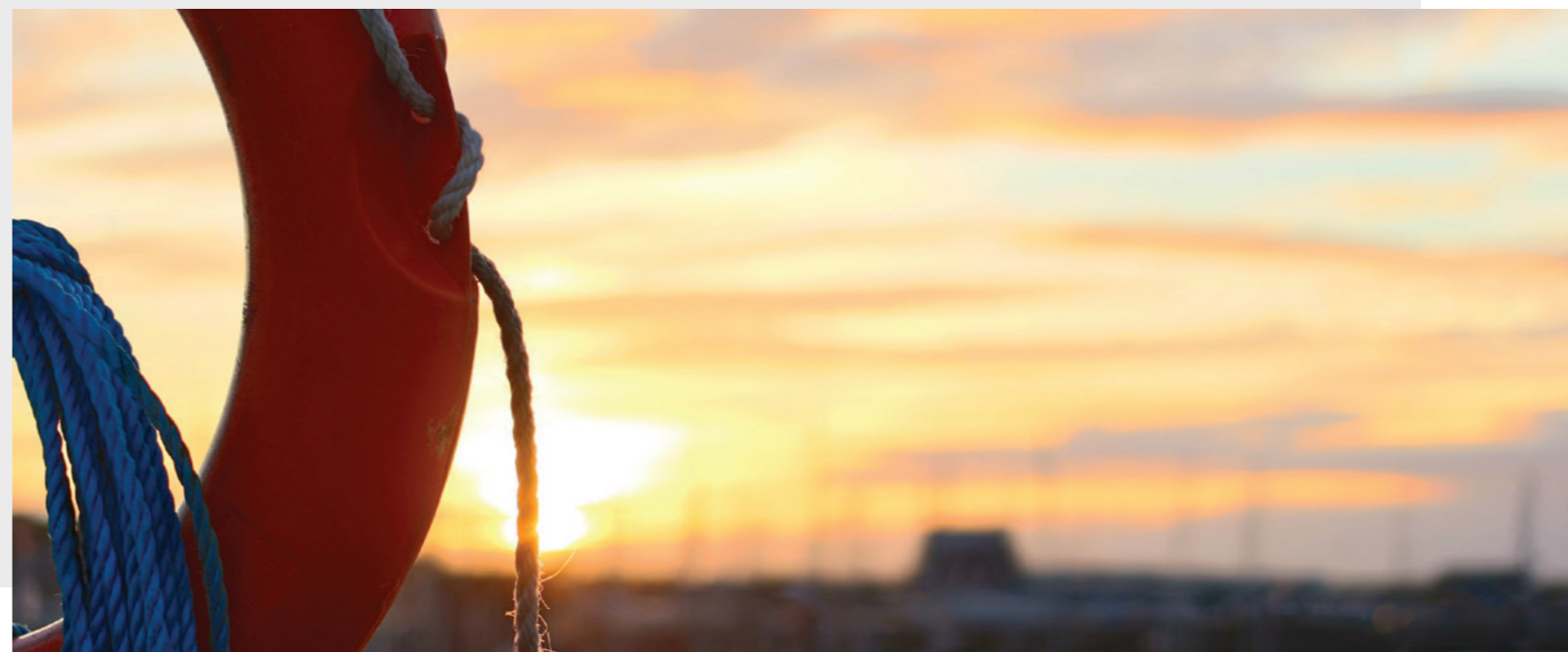



High Quality Marine Solas Inflatable LifeBuoy - Rongsheng

Code	RS-5555-I	RS-5555-II
Approval	CCS/EC/ZY	
Weight (kg)	2.5	4.3
Drop Height (m)	80	

- Ext. Diameter (mm): $\varnothing 720 \pm 5$ (2.5kg)
 $\varnothing 760 \pm 5$ (4kg)
- Int. Diameter (mm): $\varnothing 448 \pm 5$ mm (2.5kg)
 $\varnothing 468 \pm 5$ (4kg)



PROTECTIVE CLOTHING

Immersion Suit

LALIZAS Immersion Suit "Neptune", Insulated, SOLAS/MED

- Exceeds the latest SOLAS specifications for hypothermia protection
- Ideal for use on board ferries, offshore drilling rigs, rescue boats, man-overboard boats and for general commercial use
- Protects you in situations where the danger of hypothermia is great, increasing your chances of survival
- Made of reinforced neoprene material (5mm thickness)
- Ergonomic design
- Thermally insulated
- Diesel, oil & flame resistant
- Successfully submitted to water ingress, jump & leak tests
- Easy & quick donning
- Should be worn in conjunction with an approved lifejacket



- A face seal and flap
- 3-finger gloves
- Front waterproof zipper ankle cuffs
- Neoprene pocket
- SOLAS Retroreflective Tapes (70180)

LALIZAS Immersion Suit "Neptune", Insulated, with Neoprene Gloves, SOLAS/MED

Code	72745	70454	70455
Size	Small	Universal Size	XLarge
Height Range (cm)	140-160	160-190	190-210
Weight Range (kg)	40-80	55-95	85-130

RONGSHENG Neoprene Immersion Suit SOLAS Approvals

- Comply with SOLAS 1974 and latest amendment
- Certificate: CCS/EC/ZY
- Main Material: CR Expanded Neoprene Composite Cloth
- Design: inherently buoyancy, can be used without lifejacket.
- There is a pillow behind, keep head over water.
- Accessories: Lifejacket light, whistle, stainless steel harness.
- Thermal protective: The body temperature will not be 2°C lower than normal temperature after immersing in the 0°C~2°C static water for 6 hours.



Code	RSF-II			
Size	S: (150-165 cm)	M: (165-180 cm)	L: (180-195 cm)	L: (195-205 cm)





Code	04851
Material	Neoprene material

EVAl Immersion suit "PROTEUS", SOLAS/MED

- Approved according to SOLAS LSACODE MSC 81/70
- Approved according to latest SOLAS regulations
- Equipped with waterproof zipper, watertight hood, whistle, reflective tapes, neoprene pocket, fingered neoprene gloves
- Can be donned easily and does not obstruct the freedom of movement
- For general commercial use
- Material: made of neoprene material



Foam lifejacket



Code	2010-1
Type	Infant

- Brand: **Eval**
- Approval: SOLAS 74, L.S.A. CODE, 96/98/EC IMO MSC 81(70), MSC.200(80) & MSC.207(81)
- Dimension: 470 x 295 x 90 mm
- Buoyancy: 70N



Code	71076
Type	Infant
Weight (Kg)	0-15

LALIZAS Foam Lifejacket Advanced, SOLAS/MED

- Manufactured to equip all commercial vessels under SOLAS/MED
- Features lifting loop and orange buddy line for easy rescue
- Recommended to combine the lifejacket with the compatible LALIZAS Lifejacket LED Flashing Light
- Required on board EU flagged vessels as per regulations



Code	2010-2
Type	Children

- Brand: **Eval**
- Approval: SOLAS 74, L.S.A. CODE, 96/98/EC IMO MSC 81(70), MSC.200(80) & MSC.207(81)
- Dimension: 545 x 310 x 95 mm
- Buoyancy: 85N



Code	71077
Type	Child
Weight (Kg)	15-43

Code	71078
Type	Adult
Weight (Kg)	>43

LALIZAS Foam Lifejacket Advanced, SOLAS/MED

- Manufactured to equip all commercial vessels under SOLAS/MED
- Provided with lifting loop and orange buddy line for easier rescue
- Supplied in adult and child sizes
- The adult lifejacket is appropriate for passengers with chest size up to 175cm and overweight passengers
- Recommended to combine the lifejacket with the compatible LALIZAS Lifejacket LED Flashing Light
- Required on board all EU flagged vessels as per regulations



Code	2010-3
Type	Adult

- Brand: **Eval**
- Approval: SOLAS 74, L.S.A. CODE, 96/98/EC IMO MSC 81(70), MSC.200(80) & MSC.207(81)
- Dimension: 615 x 385 x 100 mm
- Buoyancy: 150N

Features

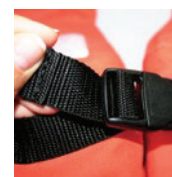

Adjustable strap (70176 & 70178)



Comfortable fit around the neck



Whistle



Lifting loop



Orange buddy line

Lifejackets can be combined with



LALIZAS Lifejacket LED Flashing Light "Safelite IV" ON-OFF Water-activated, SOLAS/MED/USCG

LALIZAS Foam Folding Lifejacket Compact, SOLAS/MED



Code	72214
Type	Adult
Weight (Kg)	43-140



Code	72215
Type	Child
Weight (Kg)	15-43



Features



Whistle



Lifting loop



Orange buddy line

Folding Options

Adult

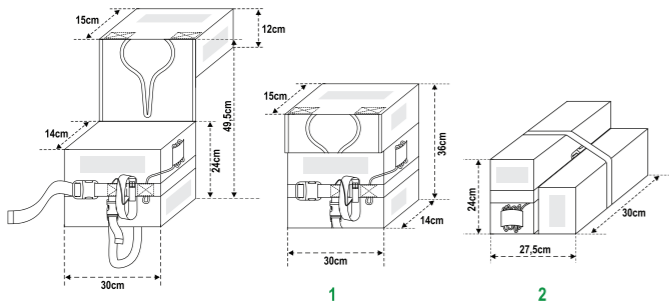

Child

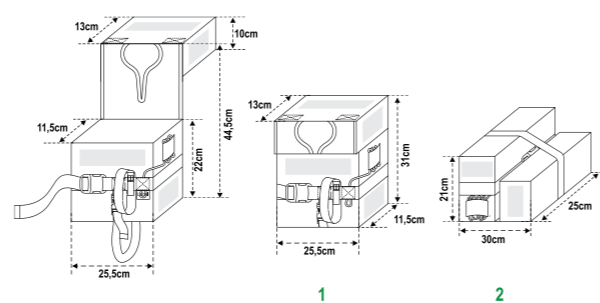



Code | RSCY - A3

- Brand: **Rongsheng**
- Solas Standard
- Fabric Material: Polyester
- Buoyancy Material: EPE
- Buoyancy: 275N
- Size: 720*320*150 mm
- Accessories: Whistle, buddy line, lifting loop
- Certificates: EC/CCS/ZY
- Suitable: offshore use under extreme conditions



Code | RSCY - A6

- Brand: **Rongsheng**
- Solas Standard
- Fabric Material: Polyester
- Buoyancy Material: EPE
- Buoyancy: 150N
- Size: 710*340*120 mm
- Accessories: Whistle, buddy line, lifting loop
- Certificates: EC/CCS/ZY
- Suitable: Body weight 43kgs-140kgs & Height above 155cm



Code | RSCY - A4

- Brand: **Rongsheng**
- Solas Standard
- Fabric Material: Polyester
- Buoyancy Material: EPE
- Buoyancy: 150N
- Size: 570*305*155 mm
- Accessories: Whistle, buddy line, lifting loop
- Certificates: EC/CCS/ZY
- Suitable: Body weight 43kgs-140kgs & Height above 155cm



Code | RSCY - A7

- Brand: **Rongsheng**
- Solas Standard
- Fabric Material: Polyester
- Buoyancy Material: EPE
- Buoyancy: 150N
- Size: 550*335*105 mm
- Accessories: Whistle, buddy line, lifting loop
- Certificates: EC/CCS/ZY
- Suitable: Body weight 43kgs-140kgs & Height above 155cm



Code | RSCY - A5

- Brand: **Rongsheng**
- Solas Standard
- Fabric Material: Polyester
- Buoyancy Material: EPE
- Buoyancy: 150N
- Size: 400*390*220 mm
- Accessories: Whistle, buddy line, lifting loop
- Certificates: EC/CCS/ZY
- Suitable: Body weight 43kgs-140kgs & Height above 155cm



Code | RSCY - A8

- Brand: **Rongsheng**
- Solas Standard
- Fabric Material: Polyester
- Buoyancy Material: EPE
- Buoyancy: 150N
- Size: 520*340*110 mm
- Accessories: Whistle, buddy line, lifting loop
- Certificates: EC/CCS/ZY
- Suitable: Body weight 43kgs-140kgs & Height above 155cm



Code | RSCY - A9

- Brand: **Rongsheng**
- Certificate: EC/CCS/ZY
- Fabric material: Polyester
- Buoyancy material: EPE
- Size: 610*320*115 mm
- Buoyancy: $\geq 155N$



Code | RSEY - 1

- Brand: **Rongsheng**
- Solas Standard
- Fabric Material: Polyester
- Buoyancy Material: EPE
- Buoyancy: 88N
- Size: 610*320*115 mm
- Accessories: Whistle, buddy line, lifting loop
- Certificates: EC/CCS/ZY
- Suitable: Body weight 15-43 kg & Height 100-155 cm



Code | RSEY - 2

- Brand: **Rongsheng**
- Solas Standard
- Fabric Material: Polyester
- Buoyancy Material: EPE
- Buoyancy: 88N
- Size: 420*290*100 mm
- Accessories: Whistle, buddy line, lifting loop
- Certificates: EC/CCS/ZY
- Suitable: Body weight 15-43 kg & Height 100-155 cm





Inflatable Lifejacket



Code | 72561

- Brand: **Lalizas**
- Standard: CE ISO 12402 - 7
- Automatic & manual activation
- Buoyancy: 170N
- Design to not burn for a while
- Inclement weather
- Maintain accurate flotation position in water (face-up)
- Fully adjustable straps
- Stainless steel D-hook for fastening safety lines



Code | 71094

- Brand: **Lalizas**
- Standard: CE ISO 12402 - 3
- Automatic & manual activation
- Buoyancy: 150N
- Chamber Structure: single
- Color: Red/Green/Yelow



Code | RSY-150

- Brand: **Rongsheng**
- Standard: EN ISO 12402 - 2:2006 + A1:2010
- Certificate: EC
- Automatic & manual activation
- Buoyancy: 150N
- Material: polyester
- Color: red
- Chamber Structure: single



Model	PX 150
Serial	13781

- Brand: **Secumar**
- Standard: DIN EN ISO 12402 - 3/12401
- Activated by compressed air CO2 (32g)
- Buoyancy: 165N
- Weight: 850g
- Color: red
- Suitable for: W >50kg, Shoulder width 70 - 135cm



Model	MYSTIC
Serial	15670

- Brand: **Secumar**
- Standard: DIN EN ISO 12402 - 3/12401
- Activated by compressed air CO2 (32g)
- Buoyancy: 165N
- Weight: 800g
- Color: black
- Suitable for: W >50kg, Shoulder width 70 - 135cm



Model	GOLF 275N TWIN
Serial	14256

- Brand: **Secumar**
- Standard: DIN EN ISO 12402 - 3/12401
- Activated by compressed air CO2 (60g)
- Buoyancy: 280N
- Weight: 1,900g
- Color: Blue-Black
- Suitable for: W >50kg, Chest circumference >175cm



Model	GOLF 150N TWIN
Serial	13970

- Brand: **Secumar**
- Standard: DIN EN ISO 12402 - 3/12401
- Activated by compressed air CO2 (32g)
- Buoyancy: 165N
- Weight: 1,400g
- Color: Blue-Black
- Suitable for: W >50kg, Chest circumference >175cm



Work Vest



LALIZAS Work Vest 50N, ISO

- Approved to the European standards for 50N buoyancy aids, ISO 12402-5
- All of its raw materials are tested per ISO 12402-7 and ISO 12402-8 for higher strength, quality and durability
- Specifically designed and manufactured for use in the work environment
- It is open on the side areas, being lightweight when wearing it
- Made of special polyester anti-fire fabric
- Its two waist webbings are adjusted by the stainless steel D-rings and hooks
- It comes with SOLAS Retroreflective Tapes (70180)
- It has a fabric pocket for placing tools or other light equipment

Code	Type	Weight (kg)	Chest Size (cm)
71144	Adult	>40	80-130



Code | RSGY-1

- Brand: **Rongsheng**
- ISO 12402-4 Standard
- Fabric Material: Polyester
- Buoyancy Material: EPE
- Buoyancy: 75N
- Certificates: ZY/CCS



Code | RSGY-3

- Brand: **Rongsheng**
- ISO 12402-4 Standard
- Fabric Material: Polyester
- Buoyancy Material: EPE
- Buoyancy: 75N
- Certificates: ZY/CCS



Code | RSY-100B

- Brand: **Rongsheng**
- Material: PVC foam
- Buoyancy: >100N
- Certificate: CCS/ZY



Code | XT-100

- Brand: **Rongsheng**
- Material: PVC foam
- Material: PVC foam
- Weight: 500g
- Size: 71x45x42mm
- Buoyancy: >75N
- Certificate: CCS/ZY

Flame Resistant Clothing



Brand	PG Products Ltd	
Code	MED FireBuddy	MED FireBuddy Plus

• The FireBuddy Suit is a two-piece garment with a three-layer construction. The outer shell is aramid. The second layer is meta-aramid felted thermal barrier quilted to the third layer of aramid/viscose lining. The jacket has a stand up collar, elasticated cuffs and is closed by a zip covered by an overlapping front with touch and close fastening to the front and collar. The trousers have wide elasticated braces with adjusters and quick-release buckles. Optional fire resistant retro reflective tape can be fitted to the wrists, hem and ankles. Optional radio and thigh pockets can be fitted as well.

Chemical Resistant Clothing



Brand	Fangzhan
Code	RHF-I



Brand	Fangzhan
Code	RHF-II

	S	M	L	XL
Size (cm)	160	166	171	177
Breasts (cm)	84	90	96	102
Waistband (cm)	68	72	76	
Boot (cm)	43	43	44	45
Suitable for (cm)	<170	170 - 180	180 - 190	>190

- Penetration time: 98% H_2SO_4 , 30% HCL , 60% HNO_3 , 40% $NaOH$
- Strength decrease rate: Vertical 98% H_2SO_4 , 30% HCL , 60% HNO_3 , 40% $NaOH$
Zonal 98% H_2SO_4 , 30% HCL , 60% HNO_3 , 40% $NaOH$
- Ambient temperature: $20^{\circ}C \pm 2^{\circ}C$
- Relative humidity: $65\% \pm 5\%$
- Splashing liquid tightness: Instructions on clothing stains total area should not exceed three times the area of standard stains
- Ejection liquid tightness: Instructions on clothing stains total area should not exceed three times the area of standard stains
- Wear: Ambient temperature $23^{\circ}C \pm 2^{\circ}C$ / Relative humidity 50%~70% (After 100 laps wear)
- Flex resistance: Ambient temperature $20^{\circ}C \pm 2^{\circ}C$ / Relative humidity $65\% \pm 5\%$ (Flex 1000 times)
- Puncture resistance: Ambient temperature - $20^{\circ}C \pm 2^{\circ}C$ / Relative humidity - $65\% \pm 5\%$



Lightweight Chemical protective clothing

- Brand: **Rongsheng**
- Chemical protective clothing is one kind of fireman protective suit,when firefighters are carrying out fire fighting and rescue at fire and accident scene with dangerous chemicals and corrosive substances ,wearing to protect themselves against hazardous chemicals or corrosive materials.
- The main material is brocade silk cloth which is fire resistance and coated chemical resistance rubber each side.
- Anti-flame-retardant surface made of: main tape in case of fire only produce carbonation, insoluble drops, also maintaining good strength.
- The fabric is produced through bonding, sewing, stickers craft and matched with flame resistance, volt-age resistance, resist puncture fire boots or rubber boots
- Certificate: CCS/ECSpecification and dimension



Size	S	M	L	XL
Suitable height(mm)	1650—1700	1700—1800	1800—1900	>1900



BREATHING EQUIPMENT

EEBD



- Brand: **Fangzhan**
- PVC visor, anti-fog
- The pressure gauge can be used in the dark
- The tape can be adjusted to fit the purpose
- Duration: >15 minutes
- Steel cylinder volume: 3L
- Weight: 7Kg
- Working Pressure: 210bar
- Total dimensions: 590 x 250 x 175 mm



- Brand: **Honeywell Fenzy**
- Bioscape 15 mins EEBD
- Duration: maximum of 15 minutes
- Steel cylinder volume: 3L
- Working Pressure: <21 MPA
- Weight: 8.5 Kg
- Alarm Pressure: 5 - 6 MPA



- Brand: **Rongsheng**
- Code: **THRS 10/THRS 15**
- Certificate: CCS/EC
- Duration: 10/15 minutes
- Steel cylinder volume: 2/3L
- Working Pressure: 21 MPA
- Weight: 8.5 Kg
- Alarm Pressure: 4 - 6 MPA

SCBA



- Brand: **Rongsheng**
- Code: **RHZK-6/30**
- Approval: CCS; EC
- Duration: 55 - 60 minutes
- Cylinder materials: carbon fibre
- Cylinder Volume: 6L
- Working Pressure: 300 bar
- Alarm Pressure: 4 - 6 MPA
- Gas storage capacity: 1,800L



- Brand: **Honeywell Fenzy**
- Duration: 45 minutes
- Breathes: composite
- Cylinder Volume: 6,9L



- Brand: **Fangzhan**
- Standard: CCS; EC; CE; RS
- Duration: 35 - 40 minutes
- Cylinder materials: steel
- Cylinder Volume: 6L
- Working Pressure: 300 bar



- Brand: **Fangzhan**
- Standard: CCS; EC; CE; RS
- Duration: 60 minutes
- Cylinder materials: carbon
- Cylinder Volume: 6L
- Working Pressure: 300 bar



GAS DETECTOR

Portable Gas Detector



Code | MGC-Simple Plus

Multi Gas Clip MGC-Simple Plus

- Brand: **Gas Clip**
- Gases: 4 gases CO; O₂; H₂S; LEL
- Temperature: -4 to 122°F
- Humidity: 5% - 95% rh (non-condensing)
- Battery Life: 1,095 days continuous
- Size: 120,65 x 69,85 x 31,75 mm
- Display: High viewing angle alphanumeric LCD
- Sensor: LEL Immune to H₂S and Silicone
- Alarms: Visual, vibrating & audible (minimum 95 dB)
- Ingress Protection: IP68



Code | MGC-Simple

Multi Gas Clip MGC-Simple

- Brand: **Gas Clip**
- Gases: 4 gases CO; O₂; H₂S; LEL
- Safe threshold:
 - LEL = 9% / 10%
 - O₂ = 19,5% / 23%
 - CO = 24 PPM / 25 PPM
 - H₂S = 5PPM
- Temperature: -4 to 122°F
- Humidity: 5% - 95% rh (non-condensing)
- Battery Life: 730 days continuous
- Alarms: Visual, vibrating & audible (minimum 95 dB)



Code | MGC-IR

Multi Gas Clip MGC-IR

- Brand: **Gas Clip**
- Gases: 4 gases CO; O₂; H₂S; LEL
- Temperature: -4 to 122°F
- Humidity: 5% - 95% (non-condensing)
- Battery Life: 2 month
- Weight: 240 g
- Safe threshold:
 - LEL = 1 - 100%
 - O₂ = 0 - 30%
 - CO = 0 - 500PPM
 - H₂S = 0 - 100PPM
- Alarms: Visual, vibrating & audible (minimum 95 dB)



Code | MGC PUMP-IR

Multi Gas Clip MGC PUMP-IR

- Brand: **Gas Clip**
- Gases: 4 gases CO; O₂; H₂S; LEL
- Battery Life: 52 hours (continuous)
- Equipped with suction pump
- Size: 120,65 x 69,85 x 31,75 mm
- Display: LCD
- Charge time: 4 - 6 hours
- Will work in inert environments, no need for oxygen
- Ingress Protection: IP67
- Calibration Frequency: 1 year



Code | H₂S

H₂S Gas Clip Single

- Brand: **Gas Clip**
- Humidity: 5% to 95% rh (non-condensing)
- Alarm limit: 10 - 15 PPM
- Battery Life: 2 years
- Alarms: Visual, vibrating & audible (minimum 95 dB)
- Ingress Protection: IP67



Code | Gas detector calibration

Gas detector calibration - Gas Clip

- Brand: **Gas Clip**
- Test 4 detectors at one time.
- Easy 1 button operation.
- Robust rechargeable internal battery, up to 1500 tests before recharging
- Internal gas cylinder regulator and pressure gauge.
- USB flash memory for bump test and event log storage.
- Optional detector configuration and firmware updates via GCT Manager Software.
- Rugged case or Wall Mount Dock case.
- No computer required to operate.



Code | UNI MP100

UNI MP100 Single Gas Detectors

- Brand: mPower Electronics Inc.
- Size: 3.46 x 2.44 x 1.3 in (88 x 62 x 33 mm) Weight: 4.4 oz (125 g)
- UL/cUL: Class I, Div 1, Group A, B, C, D; Class II, Div 1, Group E, F, G; Class III, Div 1
- Temperature rating T4, $-20^{\circ}\text{C} \leq T_{\text{amb}} \leq +50^{\circ}\text{C}$
- Event logger
- IP rating: IP-67
- Large LCD, 30% larger than most
- Password protection
- Adjustable Low, High, TWA & STEL alarms
- Six bright red flashing LEDs
- Sensors for over 20 chemicals in 30 concentration ranges
- Two-point field calibration



Code | MP812

VOXI Fixed VOC Monitor

- Brand: mPower Electronics Inc.
- Fast response $t_{90} < 5\text{s}$
- Wide range of operation -40°C to $+70^{\circ}\text{C}$
- 1 ppb VOC resolution
- Auto ranging & zeroing
- Built-in heater to prevent condensation
- Innovative PID for performance & long life
- Easy access to clean sensor and lamp
- OLED display for maximum visibility outdoors
- 450 Correction Factors
- 4-20mA, Modbus communication protocol
- 3 relays and output to strobes and horns
- Mobile apps and Bluetooth controller for handy configuration and testing
- VOC emission monitoring



Code | MP101/MP102/MP103

UNI 321 Maintenance-Free Single Gas Detectors

- Brand: mPower Electronics Inc.
- Size: 3.46 x 2.44 x 1.3 in (88 x 62 x 33 mm) Weight: 4.4 oz (125 g)
- UL/cUL: Class I, Div 1, Group A, B, C, D; Class II, Div 1, Group E, F, G; Class III, Div 1
- Temperature rating T4, $-20^{\circ}\text{C} \leq T_{\text{amb}} \leq +50^{\circ}\text{C}$
- Event logger
- IP rating: IP-67
- Large LCD, 30% larger than most
- Password protection
- Low, High, TWA & STEL alarms
- Six bright red flashing LEDs
- Two-point field calibration
- H₂S, CO and O₂ versions available
- Models: MP103 for 3-year, MP102 for 2-year, and MP101 for 1-year



Code | NEO

NEO Photo-ionization Detectors

- Brand: mPower Electronics Inc.
- Size: 9.06 x 3.15 x 2.36 in (230 x 80 x 60 mm), Weight: 25 oz (700 g)
- 1 ppb to 15,000 ppm ranges of VOC
- Benzene/Butadiene specific version with filtering tubes for measuring 0.05 to 200 ppm benzene or butadiene (NEO BENZ)
- 3-second response time
- Large and intuitive display
- Integrated Correction Factor list of more than 200 compounds
- Built-in pump for up to 30 meters sampling distance
- Man-Down alarm with real-time remote wireless notification
- ISM wireless connection option
- Easy service and maintenance
- Micro-USB charge port

Code | MP400/MP400P/
MP400S/MP400H

POLI Multi-Gas Detectorst

- Brand: mPower Electronics Inc.
- Available in diffusion or pump version
- Man Down Alarm with real-time remote wireless notification
- IP-65/67 water and dust resistant case
- Real-time gas concentration readings and alarm status enabled by state-of-the-art wireless technology
- Large graphical display icon-driven user interface through intuitive, simple-to-operate two-button user interface
- Easy access to pump, sensor, filter and battery
- Over 30 interchangeable sensor options, including PID for VOC, NDIR and catalytic for combustibles, and NDIR for CO₂
- Intelligent sensors store calibration data, so they can be swapped in the field



Code | Mobile Wireless

Mobile Wireless Multi-Gas Team Warning System

- Brand: mPower Electronics Inc.
- Remote, wireless real-time readings and alarms including Man-down
- Up to 64 remote 4- or 5-gas monitors in 8 Squads of 8 persons each
- Up to 3 km (2 miles) distance to Squad Head and 800 m within Squad
- Mobile system operation
- 12-hour continuous operation on single Li-ion battery charge
- USB Micro cable for local charge & communication
- Wide selection of sensor types

Gas Cylinders



58L Aluminum

- Pressure: 500 PSI
- Dimensions: 14,25 x 3, 53 inch
- Material: Aluminum
- Weight: 1lb 12oz
- Water Capacity: 1,72L



116L Aluminum

- Pressure: 1.000 PSI
- Dimensions: 14,3 x 3, 5 inch
- Material: Aluminum
- Weight: 2lb
- Water Capacity: 1,72L

Hand Aspirator Kit



Hand Aspirator Kit for MGC Infrared & MGC Pellistor - Probe, Stone Filter, Sampling Hose, Bulb & Calibration Cap (for use with MGC IR & Pellistor only)





Personnel Transfer Net

- Maker: **Billy Pugh**
- Origin: USA

Model	Capacity	Size (cm)	Weight (kg)
X - 870	4 people	183 x 183 x 41	116
X - 871	Apply in strong windy conditions 4 people	183 x 183 x 41	122,5
X - 871 - 6	6 people	214 x 214 x 41	158,8
X - 871 - 8	8 people	239 x 239 x 56	181
X - 871 - 10	10 people	320 x 320 x 56	226,8
X - 871 - 12	12 people	320 x 320 x 56	263

Ladder

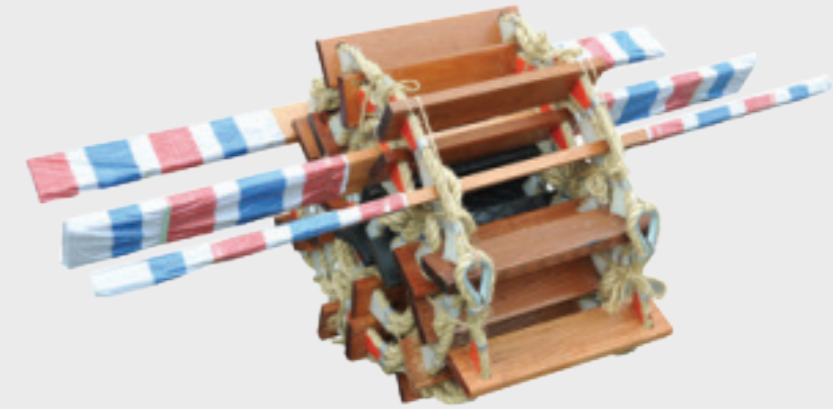

Pilot ladder

- Brand: **Rongsheng**
- Scope: Designed for pilots to safely ascend from the ship's ladder
- Comply with SOLAS 1974 and its latest amendment
- Pedal Material: lauan wood
- The bottom four: rubber pedal
- Pedal pitch: $330 \pm 20\text{mm}$
- Certificate: CCS/EC

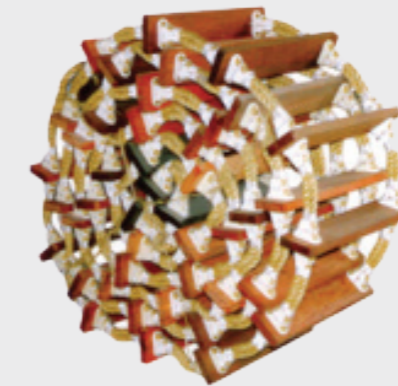

Embarkation ladder

- Brand: **Rongsheng**
- Scope: embarkation ladder apply to ships when an emergency situation occurs, the persons on board leave to the liferaft. Ladder also available to be used up and down the cabin crew .
- Comply with SOLAS 1974 and its latest amendment
- Sandard: SOLAS1974
- Pedal Material: lauan wood
- The bottom four: pedalrubber
- Pedal pitch: $330 \pm 20\text{mm}$
- Certificate: CCS/EC

Rescue Systems



Code | 72190

LALIZAS Encapsulated Lifebuoy Rescue Line, 30 m

- 30 m lifeline in plastic tube, which fits in LALIZAS lifebuoys
- Material: UV resistant polyethylene
- Dimensions: L 480 x W 130 x H 80 mm
- Weight: 950 gr
- Rope: Ø 8 mm, length 30 m
- Lifeline Breaking Load: 500 kg
- Compliance with SOLAS requirements

Mounting Instructions

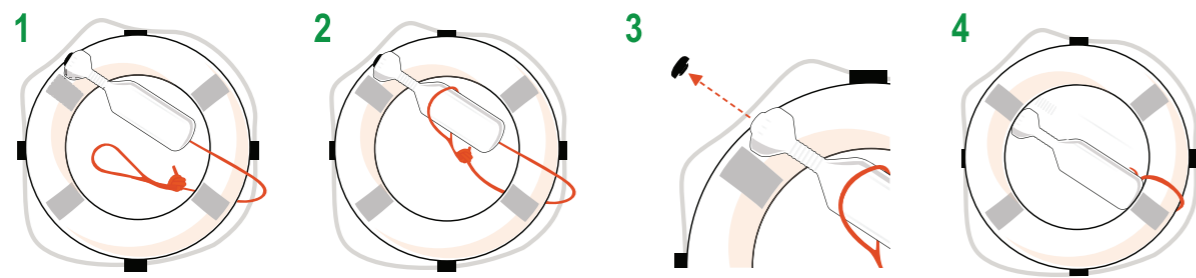

Instructions of use

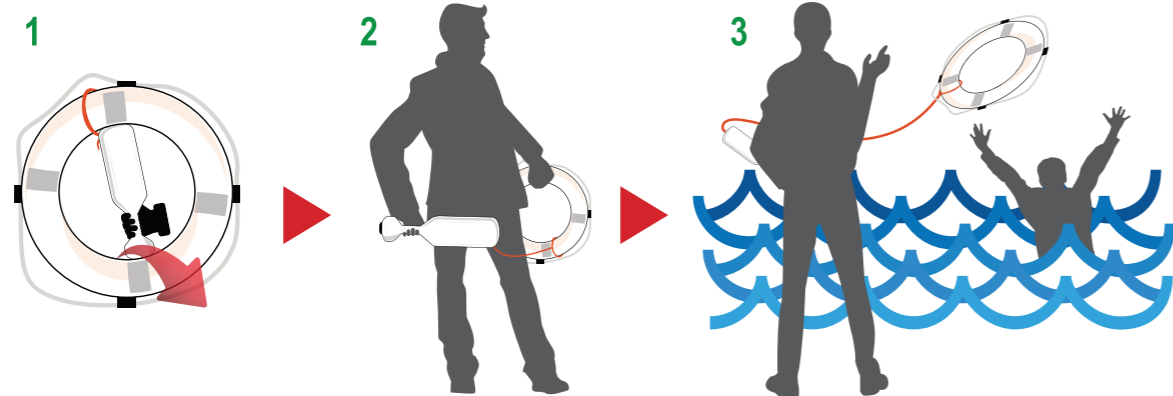

CABO Floating Line, Orange, LALIZAS

Code	Diameter (mm)	Length (m)	Strength (kg)	Material
94801	6	30	320	Polyethylene
70260	8	30	400	



CABO Floating Rope, Orange, LALIZAS

Code	Diameter (mm)	Length (m)	Strength (kg)	Material
98991	6	200	100	Polyethylene
98992	8	200	260	
98993	10	200	310	



Radar Reflector Foldable type



Radar Reflector Foldable type

- Small size, little weight, foldable, good reflectivity, can be stored and used easily.
- Technical characteristic:
- Radar cross section: $\geq 40\text{m}^2$
- Temperature range: $-35^\circ\text{C} - 55^\circ\text{C}$
- Reflectivity: $>95\%$
- Length: 470mm
- Installing height: $\geq 2\text{m}$
- G.W: $\leq 1.5\text{kg}$
- Storage: Should be stored in a dry ventilated place, avoid acid-base items. Validity: 5 years

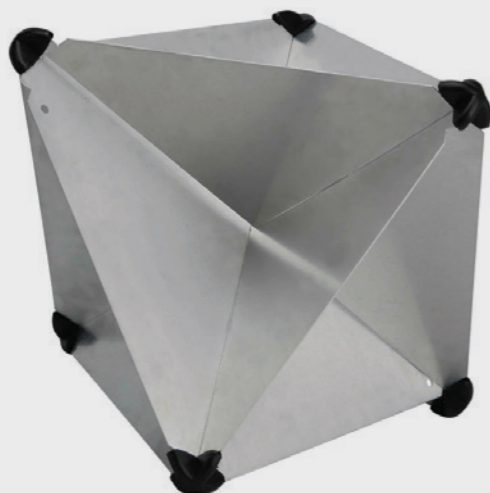

Radar Reflector

- Size:
- Radar Reflector R.O.R.C. 18", 340x340x470mm
- Radar Reflector Standard 12" 215x215x300mm
- Radar Reflector R.O.R.C. 16" 300x300x415mm

It is made of light alloy. Provided with head plastic protection. Folding model for easy storage when not required. Packed in a plastic bag.

Hydrostatic Release Units

Code | H20R



H20R REMOTE Dual Assembly

- Brand: **Hammar**
- Approvals: EC approved
- Product Specification: RFD MES type, EC approved
- Breaking Strength: White rope sling: minimum 15 kN, Weak link: 2,2 +/- 0,4 kN
- Release Depth: 1,5 - 4 m
- Weight: 0.31kg
- Color: Yellow/Green

Code | H20E



H20E for EPIRBs

- Brand: **Hammar**
- Approvals: USCG
- Weight: 0.12kg
- Color: Yellow

Replace Hammar H20E Hydrostatic Release Unit and bolt after two years of service. Use only manufacturer approved replacement bolt. Bolt not included

MEDICAL EQUIPMENT

Ambulance stretchers



Neil Robertson Stretcher

Manufactured from high quality canvas and Raminslats for increased rigidity, this uniquely designed stretcher wraps around a casualty providing protection without bulk.

- Size: 150 x 38 x 18 cm 200 x 38 x 18 cm
- Weight: 8-12kg



Basket stretcher(Seperable)

- High strength polyethylene shell, high strength aluminum frame, burly and durable
- With 12 handle, easy to grab
- Waterproof anti-infiltration, anti-rust, anti-corrosion
- Drainage holes at the bottom of the stretcher
- Inside of Stretcher is equipped with waterproof foam mattresses and foot support
- Equipped with four fixed belt for patients, quickly to decoupling
- Sling length is adjustable, karabiner durable
- Bearing: 300 kg
- Comply with SOLAS 1974 and latest amendment



Line Throwing



- Brand: **IKAROS**
- Length of line: >300m (throws a line in calm wind)
- Line strength: 2,3 KN
- Dimensions: 340 x 230 mm
- Line diameter: 4mm
- Weight: 4kg



- Brand: **HUAHAI**
- Code: JHT - 4
- Length of line: >230m (throws a line in calm wind)
- Line strength: 2 KN
- Use only for emergency signals, not directed at people.

Buoyant Smoke



- Brand: **IKAROS**
- Smoke duration: >3 min
- Dimensions: 95 x 101 mm
- Weight: 510g
- IKAROS buoyant smoke signal is globally approved and meets the latest SOLAS 74/96 regulations.



- Brand: **HUAHAI**
- Code: JHB - 4
- Smoke color: Orange
- Smoke duration: >3 min
- Dimensions: 80 x 135 mm
- Weight: 550g



Parachute Rocket Illuminating



- Brand: **IKAROS**
- Burning duration: >40s
- Flare ejection height: 350m
- Light intensity: 30.000 cd
- Dimensions: 95 x 101 mm
- Weight: 345g
- IKAROS Parachute rocket Illuminating signal is globally approved and meets the latest SOLAS 74/96 regulations.



- Brand: **HUAHAI**
- Code: JHR - 4
- Burning duration: >40s
- Flare ejection height: >300m
- Light intensity: trên 30.000 cd



Lifejacket Light



Code | LNK-SL5

Far exceeds SOLAS requirements

LNK-SL5 Manual Flashing Lifejacket Light

- Brand: **LONAKO**
- Light source: LED
- Chromaticity: White
- Battery: Alkaline batteries
- Function: Flashing
- Luminous Intensity: $\geq 0.75\text{cd}$
- Operation Life: $\geq 26\text{h}$ over 0.75cd
- Working Temperature: $-1^{\circ}\text{C} \sim +30^{\circ}\text{C}$
- Storing Temperature: $-30^{\circ}\text{C} \sim +65^{\circ}\text{C}$
- Weight: 38g (including buckle)
- Certificate: Meet MED & CCS & USCG
- Activation: manual off / manual on
- Performance: Fire-resistant, Oil-resistant, Mould-proof, Corrosion-proof, Water-proof



Code | LNK-SL5W

Far exceeds SOLAS requirements

LNK-SL5W Manual Switch Lifesaving Light

- Brand: **LONAKO**
- Light source: LED
- Chromaticity: White
- Battery: Alkaline batteries
- Function: Flashing-Steady-SOS-OFF
- Luminous Intensity: $\geq 0.75\text{cd}$
- Operation Life: $\geq 26\text{h}$ over 0.75cd
- Working Temperature: $-1^{\circ}\text{C} \sim +30^{\circ}\text{C}$
- Storing Temperature: $-30^{\circ}\text{C} \sim +65^{\circ}\text{C}$
- Weight: 38g (including buckle)
- Certificate: Meet MED & CCS & USCG
- Activation: manual off / manual on
- Performance: Fire-resistant, Oil-resistant, Mould-proof, Corrosion-proof, Water-proof



Code | LNK-SL3

Far exceeds SOLAS requirements

LNK-SL3 Alkaline Flashing Lifejacket Light

- Brand: **LONAKO**
- Light source: LED
- Chromaticity: White
- Battery: Alkaline batteries
- Function: Flashing
- Luminous Intensity: $\geq 0.75\text{cd}$
- Operation Life: $\geq 26\text{h}$ over 0.75cd
- Working Temperature: $-1^{\circ}\text{C} \sim +30^{\circ}\text{C}$
- Storing Temperature: $-30^{\circ}\text{C} \sim +65^{\circ}\text{C}$
- Weight: 38g (including buckle)
- Certificate: Meet MED & CCS & USCG
- Activation: Automatic on in water/manual off/on
- Performance: Fire-resistant, Oil-resistant, Mould-proof, Corrosion-proof, Water-proof



Code | LNK-LJ-03A1

Far exceeds SOLAS requirements

Lifejacket Light | LNK-LJ-03A1

- Brand: **LONAKO**
- Light source: LED
- Chromaticity: White
- Battery: Lithium battery
- Function: Flashing-OFF
- Luminous Intensity: $\geq 0.75\text{cd}$
- Operation Life: $\geq 28\text{h}$ over 0.75cd
- Working Temperature: $-1^{\circ}\text{C} \sim +30^{\circ}\text{C}$
- Storing Temperature: $-30^{\circ}\text{C} \sim +65^{\circ}\text{C}$
- Weight: 28g (including buckle)
- Certificate: Meet MED & USCG
- Activation: Automatic on in water/manual off/on
- Performance: Fire-resistant, Oil-resistant, Mould-proof, Corrosion-proof, Water-proof



Code | LNK-LJ-03A1W

Far exceeds SOLAS requirements

Lithium Lifejacket Light | LNK-LJ-03A1W

- Brand: **LONAKO**
- Light source: LED
- Chromaticity: White
- Battery: Lithium battery
- Function: Flashing-Steady-SOS-OFF
- Luminous Intensity: $\geq 0.75\text{cd}$
- Operation Life: $\geq 28\text{h}$ over 0.75cd
- Working Temperature: $-1^{\circ}\text{C} \sim +30^{\circ}\text{C}$
- Storing Temperature: $-30^{\circ}\text{C} \sim +65^{\circ}\text{C}$
- Weight: 30g
- Certificate: Meet MED & USCG
- Activation: Water-activation
- Performance: Fire-resistant, Oil-resistant, Mould-proof, Corrosion-proof, Water-proof



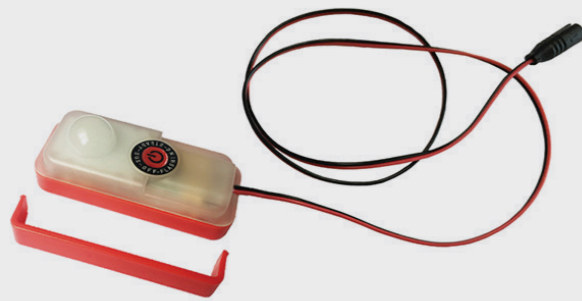

Code | LNK-SL2W

Far exceeds SOLAS requirements

LNK-SL2 Indicator Light For Inflatable Lifejacket

- Brand: **LONAKO**
- Light source: LED
- Chromaticity: White
- Battery: Alkaline batteries
- Function: Flashing-OFF
- Luminous Intensity: $\geq 0.75\text{cd}$
- Operation Life: $\geq 26\text{h}$ over 0.75cd
- Working Temperature: $-1^{\circ}\text{C} \sim +30^{\circ}\text{C}$
- Storing Temperature: $-30^{\circ}\text{C} \sim +65^{\circ}\text{C}$
- Weight: 45g (including buckle)
- Certificate: Meet MED & CCS & USCG
- Activation: Automatic on in water/manual off/on
- Performance: Fire-resistant, Oil-resistant, Mould-proof, Corrosion-proof, Water-proof

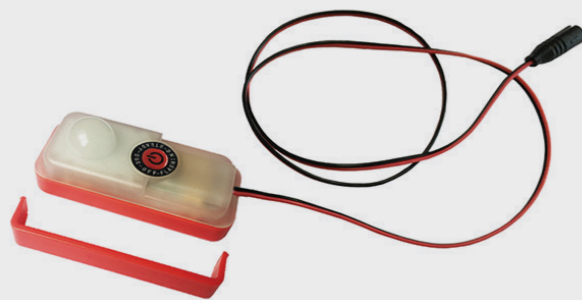

Code | LNK-SL2W

Far exceeds SOLAS requirements

LNK-SL2W Inflatable Lifejacket Light

- Brand: **LONAKO**
- Light source: LED
- Chromaticity: White
- Battery: Alkaline batteries
- Function: Flashing-Steady-SOS-OFF
- Luminous Intensity: $\geq 0.75\text{cd}$
- Operation Life: $\geq 26\text{h}$ over 0.75cd
- Working Temperature: $-1^{\circ}\text{C} \sim +30^{\circ}\text{C}$
- Storing Temperature: $-30^{\circ}\text{C} \sim +65^{\circ}\text{C}$
- Weight: 45g (including buckle)
- Certificate: Meet MED & CCS & USCG
- Activation: Automatic on in water/manual off/on
- Performance: Fire-resistant, Oil-resistant, Mould-proof, Corrosion-proof, Water-proof



Code	72348
Size	Original Size

LALIZAS Lifejacket LED Flashing Light "Alkalite II", SOLAS/MED/USCG

- Brand: **LALIZAS**
- Water-activated LED flashlight technology
- Extra powerful LED light: Offers lower consumption, longer life and operates automatically when it comes in contact with water
- ON-OFF button operation: To turn it ON-OFF when out of water
- Durable plastic body: 100% Waterproof via ultrasound welding & epoxy resin for extra safety
- Universal size clamp: Fits & locks easily in two moves with every 20 - 50 mm lifejacket belt, providing security & stability against sudden moves of panic
- Easy-to-read marking for instant inspection
- Alkaline battery: Ensures 5 year lifetime and more than 8 hours of continuous operation. Smoother and easier waste



Code	72349
Size	Original Size

LALIZAS Lifejacket LED Flashing Light "Safelite IV", SOLAS/MED/USCG

- Brand: **LALIZAS**
- Water-activated LED flashlight technology
- Extra powerful LED light: Offers lower consumption, longer life and operates automatically when it comes in contact with water
- ON-OFF button operation: To turn it ON-OFF when out of water
- Durable plastic body: 100% Waterproof via ultrasound welding for extra safety
- Universal size clamp: Fits & locks easily in two moves with every 20 - 40 mm lifejacket belt, providing security & stability against sudden moves of panic
- Easy-to-read marking for instant inspection
- Lithium battery: Ensures 5 year lifetime and more than 8 hours of continuous operation. Better performance in



Code | RSYD-A

Rongsheng Lifejacket Light RSYD-A

- Brand: **Rongsheng**
- Comply with SOLAS 1974 and latest amendment
- Manual switch
- Illuminant: LED
- Flare time: more than 8 hours
- Luminous Intensity: more than 0.75cd
- Flash Frequency: 50-70 times/minute
- Battery: Lithium battery CR123A
- Validity: 5 years
- Certificate: CCS/EC/ZY



Code | RSQD-2

Rongsheng Lifebuoy Light RSQD-2

- Brand: **Rongsheng**
- Comply with SOLAS 1974 and latest amendment
- Flare time: more than 2 hours
- Illuminant: LED
- Luminous Intensity: more than 2.0 cd
- Flash Frequency: 50-70 times/minute
- Validity: 5 years
- Certificate: CCS/EC/ZY



Code | RSQD-EX

Rongsheng Lifebuoy Light RSQD-EX

- Brand: **Rongsheng**
- Comply with SOLAS 1974 and latest amendment
- Flare time: more than 2 hours
- Illuminant: LED
- Luminous Intensity: more than 2.0 cd
- Flash Frequency: 50-70 times/minute
- Validity: 5 years
- Certificate: CCS/EC
- Battery: Lithium battery CR123A

LifeBouy Light



Code | LNK-LB-02B
Far exceeds SOLAS requirements

Mini Solas Self-Igniting Lifebuoy Light LNK-LB-02B

- Brand: **LONAKO**
- Light source: LED
- Chromaticity: White
- Battery: Alkaline batteries
- Function: Flashing
- Luminous Intensity: $\geq 2.0\text{cd}$
- Operation Life: 24h at full intensity
- Working & Storing Temperature: $-30^{\circ}\text{C} \sim +65^{\circ}\text{C}$
- Weight: 114g (including clip)
- Certificate: SOLAS MED
- Activation: Automatic when raft inflated/manual off/on
- Performance: Fire-resistant, Oil-resistant, Mould-proof, Corrosion-proof, Water-proof



Code | LNK-LB-01B
Far exceeds SOLAS requirements

Led Self-Igniting Lifebuoy Marker Light LNK-LB-01B

- Brand: **LONAKO**
- Light source: LED
- Chromaticity: White
- Battery: Lithium battery
- Function: Flashing
- Luminous Intensity: $\geq 2.0\text{cd}$
- Operation Life: 24h at full intensity
- Working & Storing Temperature: $-30^{\circ}\text{C} \sim +65^{\circ}\text{C}$
- Dimension: 90*124mm
- Certificate: Meet MED & USCG
- Activation: Automatic when raft inflated/manual off/on
- Performance: Fire-resistant, Oil-resistant, Mould-proof, Corrosion-proof, Water-proof

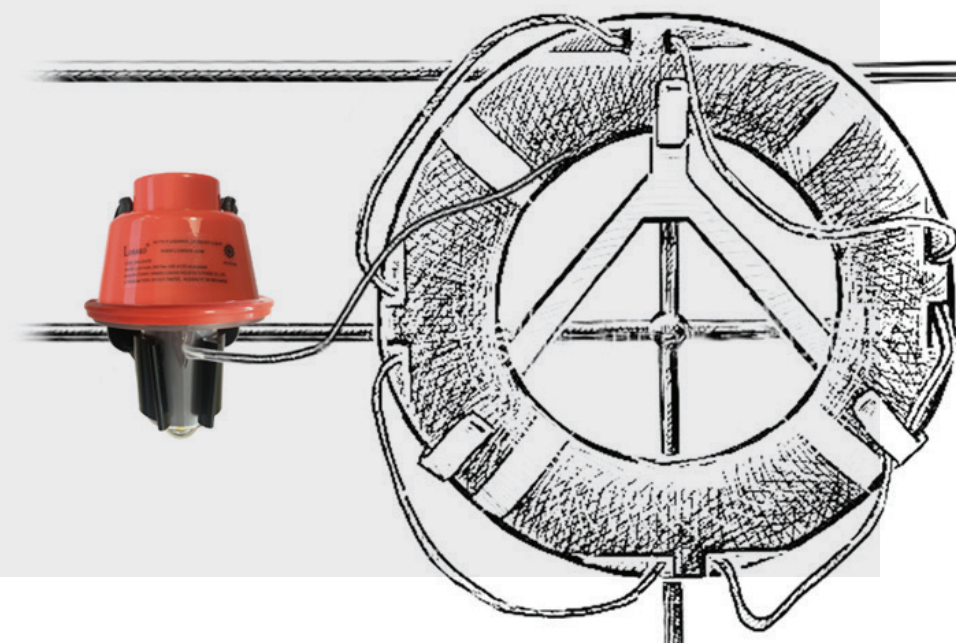



HUAHAI Lifebuoy Self-igniting Light & Self-acti (MOB)

- Brand: **HUAHAI**
- Light intensity: ≥ 2 cd
- Burning time: ≥ 2 h
- Smoke colour: Orange
- Smoke duration time: ≥ 15 min

Warning:

- Use for distress signal only.
- Don't direct outlet to person.



Code | JHL-4 & JHLS-4

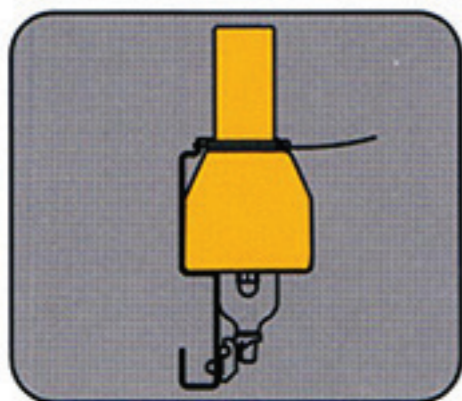

Turn on switch, connect line to lifebuoy, fasten nut, take out safety pin.

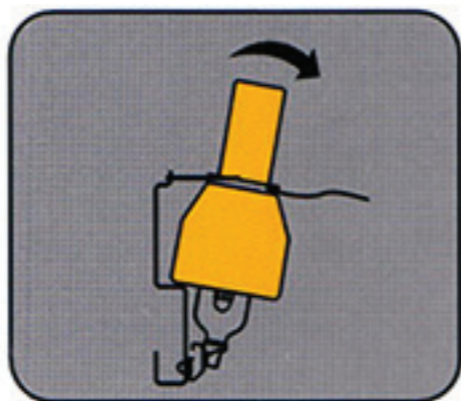

Activating quick release device of life buoy Signal falls Down and ignites automatically.

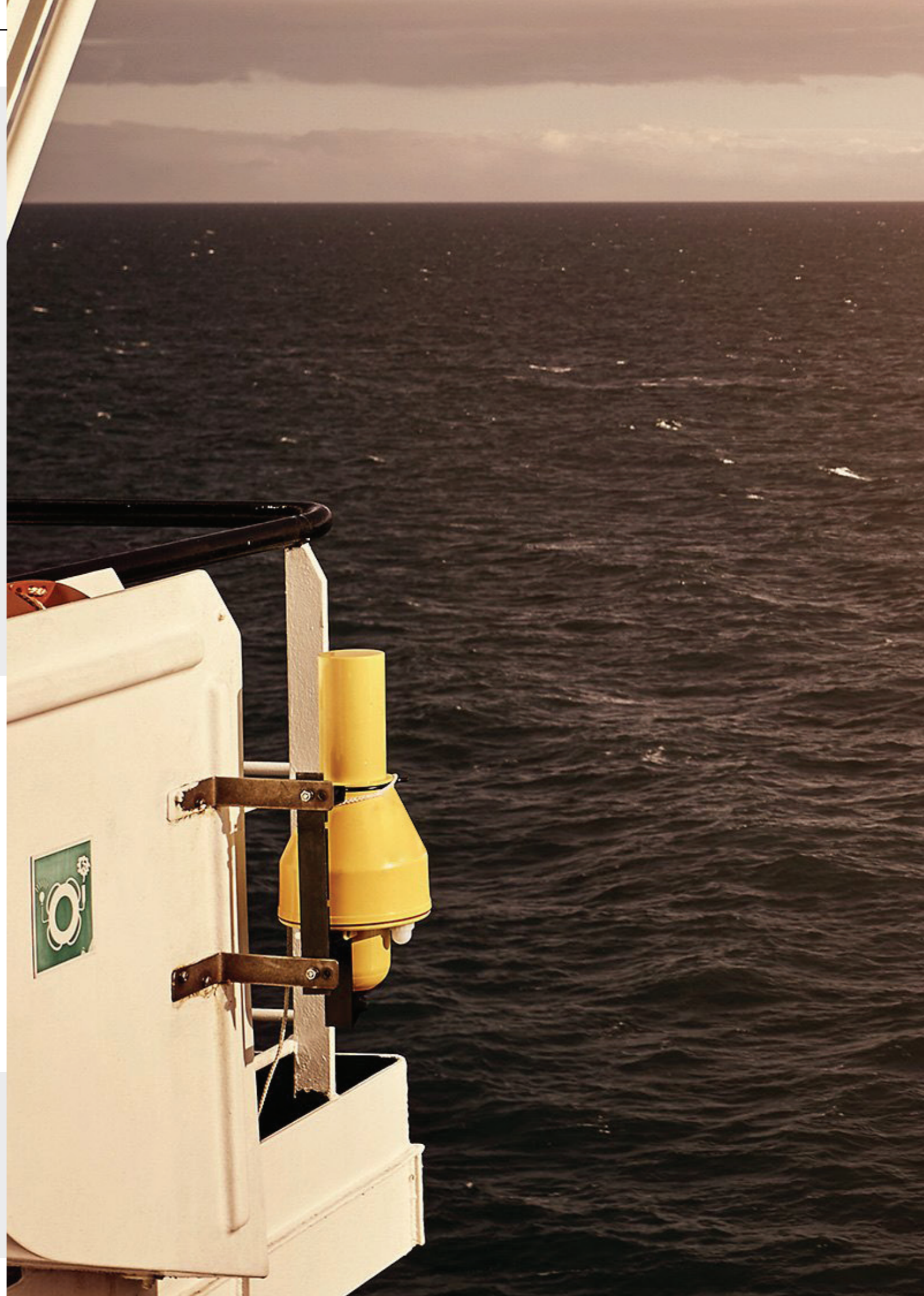



Code | 196482



LALIZAS Lifebuoy LED Light STELLA, SOLAS/MED

- Brand: **LALIZAS**
- Floating lifebuoy light with high-visibility LED light
- Very compact lifebuoy light, low power consumption
- LED-type flashlight, operates with one R20 alkaline battery. 360° arc of visibility
- Dimensions: 160 x 80 x 80 mm
- Weight: 90 g. (without battery)
- Light intensity: 2 cd
- Duration: Approx. 8 hours at 60 flash/minute
- Battery: 1 x R20 battery / D type (not included)
- SOLAS/MED approved
- 3m rope included



Code | 70030



LALIZAS Lifebuoy Light M.O.B SOLAS/MED/USCG

(LALIZAS offers you optimum visibility at sea with its classic marine product, the Lifebuoy Light M.O.B which complies with SOLAS and is capable of burning continuously with high luminous intensity)

- Brand: **LALIZAS**
- SOLAS/MED/USCG approved
- Not less than 2cd in all directions of the upper hemisphere for a period of at least 2h (in white colour)
- To be used with 4 alkaline batteries Size D

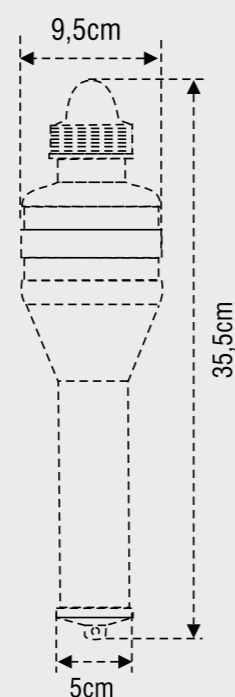

LALIZAS Lifebuoy Light SOLAS/MED/USCG - ATEX/IECEX

(LALIZAS Lifebuoy Light uses flashing light with LED technology and is designed to withstand the toughest rigours of the commercial and offshore sectors. It is completely watertight with a compact structure and designed to be tamper proof, corrosion resistant and to deliver, as a minimum standard, an omnidirectional over 2cd output for at least 2 hours. It is specifically designed to be highly resistant to accidental damage on board. Meeting full SOLAS and EC MED approvals, it is also approved to both ATEX and IECEx standards making it the only choice for hazardous installations such as offshore oil rigs, gas and oil tankers (for use in hazardous zones 0,1 and 2))



Code | 71326

- Floating lifebuoy light with high-visibility LED light
- Very compact lifebuoy light, low power consumption
- LED-type flashlight, operates with one R20 alkaline battery.
- 360° arc of visibility
- Dimensions: 160 x 80 x 80 mm
- Weight: 90 g. (without battery)
- Light intensity: 2 cd
- Duration: Approx. 8 hours at 60 flash/minute
- Battery: 1 x R20 battery / D type (not included)
- SOLAS/MED approved
- 3m rope included

LALIZAS Lifebuoy Light SOLAS/MED/USCG

(LALIZAS Lifebuoy Light uses flashing light with LED technology and is designed to withstand the toughest rigours of the commercial and offshore sectors. It is completely watertight with a compact structure and designed to be tamper proof, corrosion resistant and to deliver, as a minimum standard, an omnidirectional over 2cd output for at least 2 hours.)



Code | 71325

- SOLAS/MED/USCG approved
- Five-year lifetime
- No maintenance or replacement batteries are required
- Supplied complete with bracket & 1m Lifebuoy Lanyard
- Compact size
- Mounting bracket with easy fitting in all locations
- Advanced LED technology for low consumption and enhanced reliability

Liferaft Light



Code | LNK-LR-01A

Far exceeds SOLAS requirements

Liferaft Light | LNK-LJ-03A1

- Brand: **LONAKO**
- Chromaticity: White
- Battery: Lithium battery
- Function: External light: Flashing | Internal light: Steady
- Light Output of External Light: $\geq 4.3\text{cd}$
- Light Output of Internal Light: $\geq 0.5\text{cd}$
- Operation Life: $\geq 15\text{h}$ over 4.3cd
- Working & Storing Temperature: $-30^{\circ}\text{C} \sim +65^{\circ}\text{C}$
- Weight: About 134g (Contains light line)
- Certificate: Meet MED & USCG
- Activation: Automatic when raft inflated/manual off/on
- Performance: Fire-resistant, Oil-resistant, Mould-proof, Corrosion-proof, Water-proof



Code | LNK-LR-02C

Far exceeds SOLAS requirements

Liferaft Light, Liferaft Canopy Indicating Light LNK-LR-02C

- Brand: **LONAKO**
- Chromaticity: White
- Battery: Lithium battery
- Function: External light: Flashing | Internal light: Steady
- Light Output of External Light: $\geq 4.3\text{cd}$
- Light Output of Internal Light: $\geq 0.5\text{cd}$
- Operation Life: $\geq 18\text{h}$ over 4.3cd
- Working & Storing Temperature: $-30^{\circ}\text{C} \sim +65^{\circ}\text{C}$
- Weight: About 223g
- Certificate: Meet MED & USCG
- Activation: Automatic when raft inflated
- Performance: Fire-resistant, Oil-resistant, Mould-proof, Corrosion-proof, Water-proof

Compact Size Liferaft Canopy Light For Small Raft | LNK-LR-03A



Code | LNK-LR-03A

Far exceeds SOLAS requirements

- Brand: **LONAKO**
- Chromaticity: White
- Battery: Lithium battery
- Function: External light: Flashing | Internal light: Steady
- Light Output of External Light: $\geq 4.3\text{cd}$
- Light Output of Internal Light: $\geq 0.5\text{cd}$
- Operation Life: $\geq 12\text{h}$ over 4.3cd
- Working & Storing Temperature: $-30^{\circ}\text{C} \sim +65^{\circ}\text{C}$
- Weight: About 119g
- Certificate: Meet MED & USCG & CCS
- Activation: Automatic when raft inflated
- Performance: Fire-resistant, Oil-resistant, Mould-proof, Corrosion-proof, Water-proof

FlashLight



Code | 60170

Brightstar Flashlight - Razor FSL

- Power Source: 3 AA-cell Alkaline Batteries
- Lamp: Advanced LED Technology
- Color: High-Vis Yellow
- Output: High 325 Lumens, Low 125 Lumens, Downlight 150 Lumens, Dual Mode (Forward + Downlight) 300 Lumens
- Peak Beam Intensity: High 14,000 Candela, Low 7,000 Candela, Downlight 1,000 Candela
- Beam Distance: High 236 meters, Low 167 meters, Downlight 63 meters
- Ingress Protection: Waterproof 1 Meter IPX7
- Run Time: High 7 Hours, Low 24 Hours, Downlight 20 Hours, Dual Mode (Forward + Downlight) 10 Hour
- Dimensions (LxWxH): 7.125x2x2 in



Code | 60160

Brightstar Flashlight - NEW Razor

- Power Source: 3 AA-cell Alkaline Batteries
- Lamp: Advanced LED Technology
- Color: High-Vis Yellow Light
- Output: High 325 Lumens, Low 125 Lumens
- Peak Beam Intensity: High 14,000 Candela, Low 7,000 Candela
- Beam Distance: High 236 meters, Low 167 meters
- Ingress Protection: Waterproof 1 Meter IPX7
- Run Time: High 7 Hours, Low 24 Hours
- Dimensions (LxWxH): 7.125x2x2 in



Code | 2217 ATEX

Brightstar Flashlight - Worksafe 2217 ATEX

- Power Source: 2D-Cell alkaline batteries
- Light Source: LED
- Light Output: 80 Lumens
- Peak Beam Intensity: 2,450 candela
- Beam Distance: 100 Meters
- Run Time: 200 Hours
- Dimensions (LxWxH): 1.43x1.43x1.43 ft
- Colors: Black Housing, Safety Orange Lens Rim



Code | 2217 LED

Brightstar Flashlight - Worksafe 2217 LED

- Power Source: 2D-Cell alkaline batteries
- Light Source: LED
- Light Output: 80 Lumens
- Peak Beam Intensity: 2,450 candela
- Beam Distance: 100 Meters
- Run Time: 200 Hours
- Dimensions (LxWxH): 8.2x4.9x5.6 in
- Colors: Safety Orange, Black Lens Rim



Code | 2224 LED

Brightstar Flashlight- Worksafe 2224 LED

- Power Source: 3D-Cell alkaline batteries
- Light Source: LED
- Light Output: 60 Lumens
- Peak Beam Intensity: 1,930 candela
- Beam Distance: 88 Meters
- Run Time: 250 Hours
- Dimensions (LxW): 10.2x2.3 in
- Colors: Safety Orange, Black Lens Rim





Code | 2206 LED

Brightstar Flashlight - Worksafe 2206 LED

- Power Source: 4D-Cell alkaline batteries
- Light Source: LED
- Light Output: 90 Lumens
- Peak Beam Intensity: 7,000 candela
- Beam Distance: 165 Meters
- Run Time: 150 Hours (alkaline batteries)
- Dimensions (LxWxH): 8.2x4.9x5.6 in
- Colors: Safety Orange, Black Lens Rim



Code | 2217 ATEX

Brightstar Flashlight - Worksafe 2217 ATEX

- Power Source: 4D-Cell alkaline batteries
- Light Source: LED
- Light Output: 90 Lumens
- Peak Beam Intensity: 7,000 candela
- Beam Distance: 165 Meters
- Run Time: 150 Hours (alkaline batteries)
- Dimensions (LxWxH): 8.2x4.9x5.6 in
- Colors: Safety Orange, Black Lens Rim



Code | 60500

Brightstar Flashlight - Ion Pen Light

- Power Source: 2 AAA Batteries (not included)
- Light Source: LED
- Light Output: 135 Lumens
- Peak Beam Intensity: 250 candela
- Beam Distance: 32 Meters
- Run Time: 3 Hours
- Dimensions (LxWxH): 5/8x5/8x2 in
- Colors: Safety Orange, Black Lens Rim



Code | Hi-vis Green

Brightstar Flashlight - Vision LED Rechargeable Headlamp

- Power Source: Lithium Polymer Batteries
- Lamp: Advanced LED Technology
- Light Output: 185 Lumens (high mode)
65 lumens (low mode)
- Peak Beam Intensity: 1,000 candela
- Beam Distance: 63 Meters on high mode
14 meters on low mode
- Dimensions (LxWxH): 2.4x1.4x1.8 in



Code | Hi-vis Green #200501

Brightstar Flashlight - Vision LED Headlamp

- Power Source: 3AA Cell Alkaline Batteries
- Lamp: Advanced LED Technology
- Light Output: 185 Lumens (high mode)
65 lumens (low mode)
- Peak Beam Intensity: 7,000 candela
- Beam Distance: 65 Meters on high mode
35 meters on low mode
- Dimensions (LxWxH): 2.4x1.4x1.8 in



Code | Hi-vis Green #200511

Brightstar Flashlight - Vision Flood

- Power Source: 2AA Cell Alkaline Batteries
- Lamp: Advanced LED Technology
- Light Output: 125 Lumens (high mode)
15 lumens (low mode)
- Runtime: 2 Hours on High Mode, 13 Hours on Low Mode
- Dimensions (LxWxH): 2.4x1.4x1.4 in



Code | 510304

Brightstar Flashlight - Responder Right Angle

- Power Source: 6 AA Alkaline Batteries
- Lightsource: Advanced LED Technology
- Light Output: 220 Lumens
- Peak Beam Intensity: 60,000
- Beam Distance: 490 Meters
- Runtime: 17 Hours (alkaline battery pack)
- Weight: 1lb with alkaline battery pack
- Length: 2.5 in.
- Width: 3 in.
- Width: 7 in.



Code | 510241/501242

Brightstar Flashlight Responder Right Angle Rechargeable

First of its kind, a Right Angle LED Rechargeable with a Lithium Ion Battery. Extremely lightweight with a powerful output at 205 lumens.

- Power Source: Lithium Ion Rechargeable Battery Pack
- Lightsource: Advanced LED Technology
- Light Output: 205 Lumens
- Peak Beam Intensity: 55,000
- Beam Distance: 477 Meters
- Runtime: 4 Hours
- Weight: 11 oz. with alkaline battery pack
- Length: 7.2 in.
- Width: 3.2 in.
- Depth: 1.8 in.

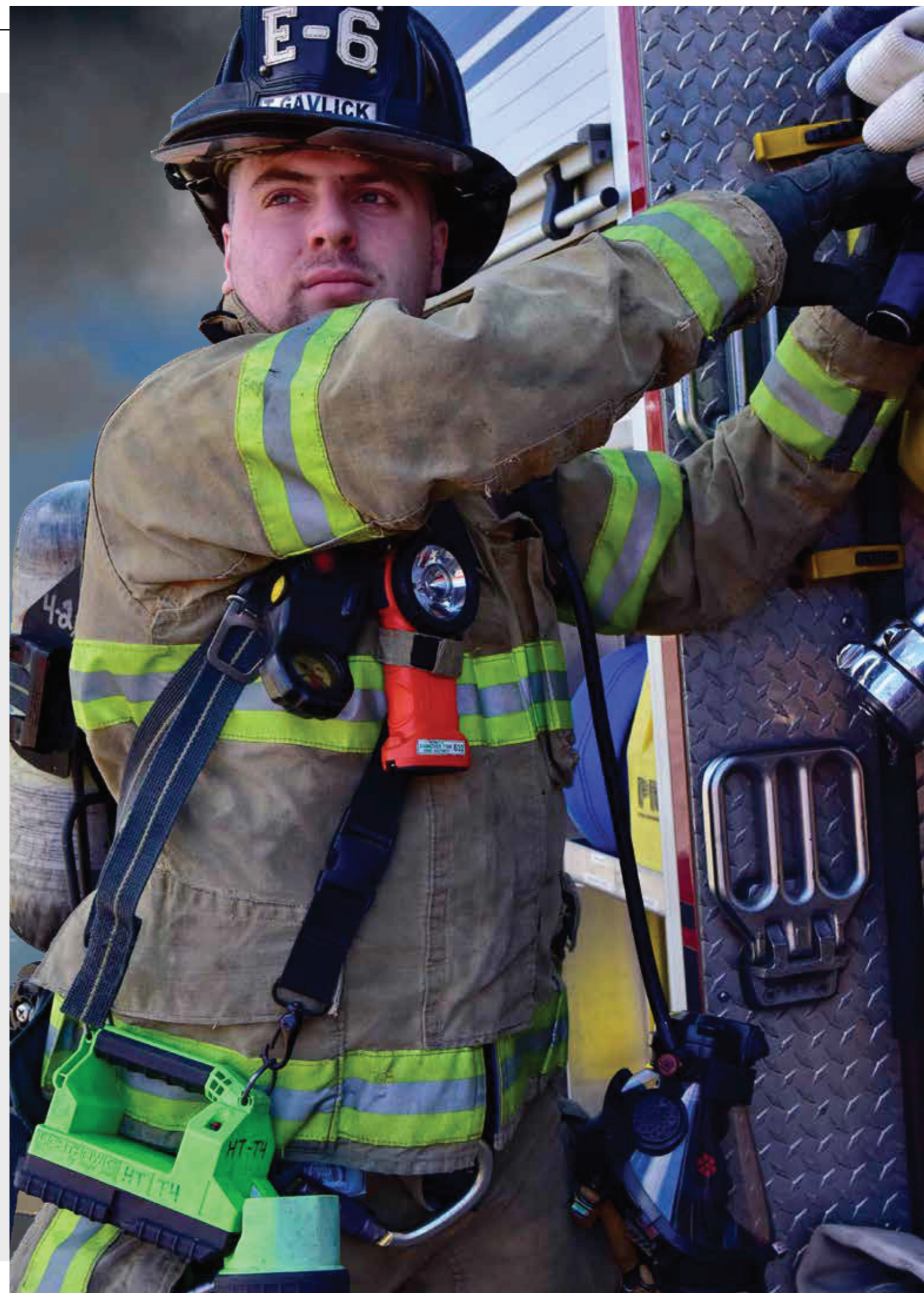



Code | EX-6180

**Centurion Flashlight
EX-6180 ATEX Intrinsicly Safe 2D Primary Cells**

- Enclosure: Impact-resistant thermoplastic, fire-retardant
- Beam Distance: 80 Meters
- Output: 120 Lumens (effective lumens)
- Light Duration: Up to 15 Hours
- Light Source Type: High power LED bulb
- Power: 3V 1.7W
- Power Source: 2 x LR20(D) Primary alkaline cells
- Ingress Protection: IP67
- Impact Resistant: 2.5 Meters
- Product Weight: 176g (without batteries)

**Centurion Flashlight
EX-5180 ATEX Intrinsicly Safe 4AA LED Flashlight**



Code | EX-5180

- Beam Type: Spot
- Beam Distance: Up to 189 Meters
- Output Mode: High/Low
- Output: 178 Lumens (High) / 46 Lumens (Low) (effective lumens)
- Light Duration: 8.75 hours (High) / 20.4 hours (Low)
- Light Source Type: High efficiency LED
- Power: 6V 3W
- Power Source: 4xAA (LR6) Alkaline cells
- Ingress Protection: IP68
- Impact Resistant: 2 Meters
- Product Weight: 150g (w/o battery)

**Centurion Flashlight
EX-7180 ATEX Intrinsicly Safe 2AAA LED Mini**



Code | EX-7180

- Ambient Temperature: -20°C~+40°C
- Beam Type: Spot
- Beam Distance: 35 Meters
- Output: 53 Lumens (effective lumens)
- Light Duration: Up to 4.4 Hours
- Light Source Type: High Power LED bulb
- Power: 3V 0.6W
- Power Source: 2 x LR3 (AAA) Alkaline Batteries
- Ingress Protection: IP68
- Impact Resistant: 1.5 Meters
- Product Weight: 31g (without battery)



Code | EX-5380

**Centurion Flashlight
EX-5380 Intrinsicly Safe 2AA Powered LED**

- Beam Type: Spot
- Beam Distance: 81 Meters
- Output: 112 Lumens (effective lumens)
- Light Duration: 4.75 hours
- Light Source Type: High Power LED bulb
- Power: 3V 1.2W
- Power Source: 2 x LR6 (AA) Alkaline Batteries
- Ingress Protection: IP67
- Impact Resistant: 1.8 Meters
- Product Weight: 114g (without battery)



Code | EX-2980

**Centurion Flashlight
EX-2980 ATEX Intrinsicly Safe Head Light**

- Beam Type: Spot / Flood
- Beam Distance: 58 Meters
- Output Mode: High / Low / Flood / Strobe Light
- Output: 130 Lumens (High) / 40 Lumens (Low) / 82 Lumens (Flood) / 130 Lumens (Strobe light)
- Light Duration: 5.3 Hours (High) / 16 Hours (Low) / 11.5 Hours (Flood) / 7.5 Hours (Strobe Light)
- Light Source Type: High power LED bulb
- Power: 4.5V 1.8W
- Power Source: 3 X LR03(AAA) Alkaline batteries
- Ingress Protection: IP67
- Impact Resistant: 2 Meters
- Production Weight: 116g (without batteries)



Code | EX-4DCL

**Centurion Flashlight
EX-4DCL Intrinsicly Safe Safety Hand Lamp**

- Beam Type: Spot
- Beam Distance: 50 Meters
- Output: 45 Lumens (effective lumens)
- Light Duration: Up to 20 hours
- Light Source Type: LED Bulb (HL-250 Only)
- Light Source Life: 25,000 Hours
- Power: 6V, 1W
- Power Source: 4 X LR20(D) Alkaline cells
- IP Protection: IP66
- Product Weight: 850g (without battery and shoulder strap)



Code | EX-250RL

**Centurion Flashlight
EX-250RL Intrinsically Safe Rechargeable Safety**

- Beam Type: Spot
- Beam Distance: 50 Meters
- Output: 45 Lumens (effective lumens)
- Light Duration: Up to 21 hours
- Light Source Type: LED Bulb (HL-250 Only)
- Light Source Life: 25,000 Hours
- Power: 4V, 1W
- Power Source: Rechargeable battery, lithium-ion 4.2V 7.5Ah
- Battery Life: Up to 500 Recharge cycles
- IP Protection: IP66
- Compatible Charger: LC-250 (charging time: 9.5 hours)
- Product Weight: 1.145kg (including battery but without shoulder strap)



Code | AT-1380

**Centurion Flashlight
AT-1380 ATEX Intrinsically Safe Rechargeable Safety**

- Beam Type: Spot
- Beam Distance: 191 Meters
- Output: 247 Lumens (effective lumens)
- Light Duration: Up to 19.3 Hours
- Light Source Life: 100,000 Hours
- Light Source Type: High efficiency LED
- Power: 3.7-4.2V 4W
- Power Source: Rechargeable Battery, B-250R-A, Lithium-Ion 3.7-4.2V 7.5Ah
- Compatible Charger: LC-250
- Charging Time: 9.5 Hours
- Ingress Protection: IP66
- Impact Resistance: 1.5 Meters
- Product Weight: 1.196 kg



Code | EX-2680

**Centurion Flashlight
EX-2680 ATEX Intrinsically Safe Head Light**

- Beam Type: Spot
- Beam Distance: 76 Meters
- Output: 100 Lumens (effective lumens)
- Light Duration: Up to 8 hours
- Light Source Type: LED bulb
- Power: 6V 1.8W
- Power Source: 4 X LR6(AA) Alkaline batteries
- Ingress Protection: IP68
- Impact Resistant: 1.8 Meters
- Product Weight: 173g (without batteries)





G1

G3

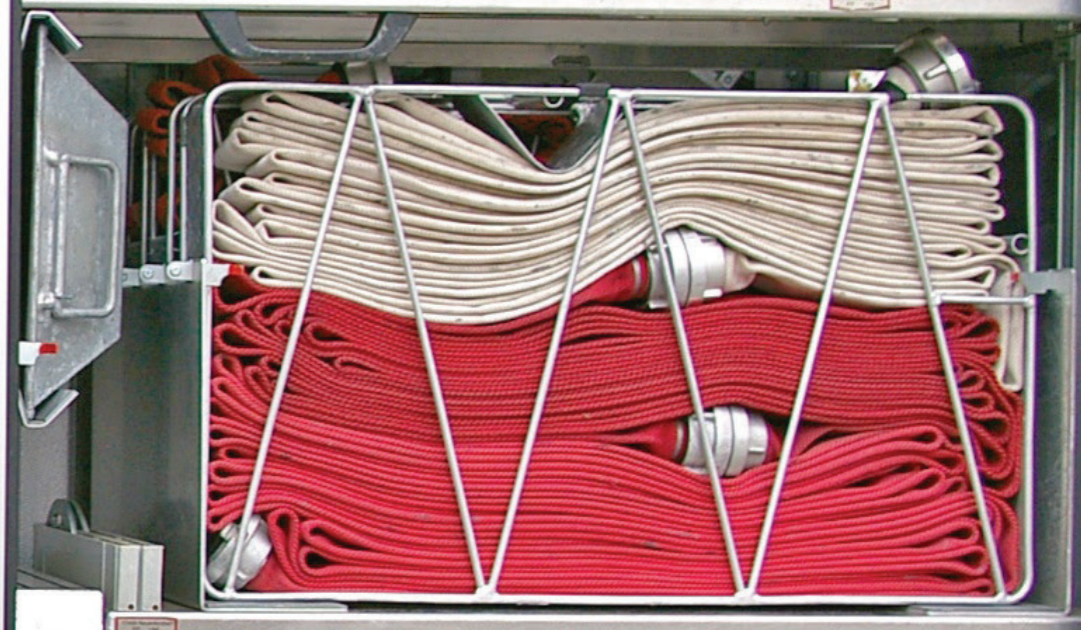

FIRE FIGHTING EQUIPMENTS

FIRE EXTINGUISHER

Carbon Dioxide (CO₂) Fire Extinguisher



2 Kg



5 Kg

CO2 Stored Pressure Fire Extinguisher COMBAT

Brand	COMBAT (Lingjack)	
Capacity	2 Kg	5 Kg
Extinguishing Medium	CO ₂	
Propellant Type	CO ₂	
Fire Rating	34B	55B
Class of Fire	B	B
Discharge Time	9.8 sec	13 sec
Discharge Range	2 m	2 m
Working Pressure	60 bar	
Working Temperature	-20Deg C to 60 Deg C	
Finishing	RAL 3000	
Hose Length	440 mm	
Size	Dia. 114 x 500(H) mm	Dia. 115x 645(H) mm
Gross Weight	Approx. 7.5 kg	Approx. 17.0 kg



Code	K2S
Capacity	2 Kg



Code	K5S
Capacity	5 Kg

RUIHUA Carbon dioxide fire extinguisher

Brand	RUIHUA	
Product Code	K2S	K5S
Capacity	2 Kg	5 Kg
Fire Rating	34B	89B
Discharge Time	Approx. 10.07 sec	Approx. 12.5 sec
Dimensions	Dia. 115 x 600(H) mm	Dia. 140 x 790(H) mm
Overall Mass	Approx. 6.49 kg	Approx. 13.48 kg

- Powder coated with UV resistant paint finish.
- High pressure hose assembly with the Bell Horn design.
- 316 Stainless steel handles and levers – suitable for aggressive environments.
- CO2 is a clean nontoxic gas ideal for office areas with computers or sensitive electronics.
- Sturdy solid stainless steel hanging bracket.
- Fire extinguishers have been fire tested for the use in B & E Class fires. Rating is an indication of the level of fire testing achieved. Fire professionals carry out all testing.
- All fire extinguishers should be serviced to the relevant, current Australian Standard. AS1851 -Maintenance of Fire Protection Systems and Equipment.



Fire Extinguisher Powder

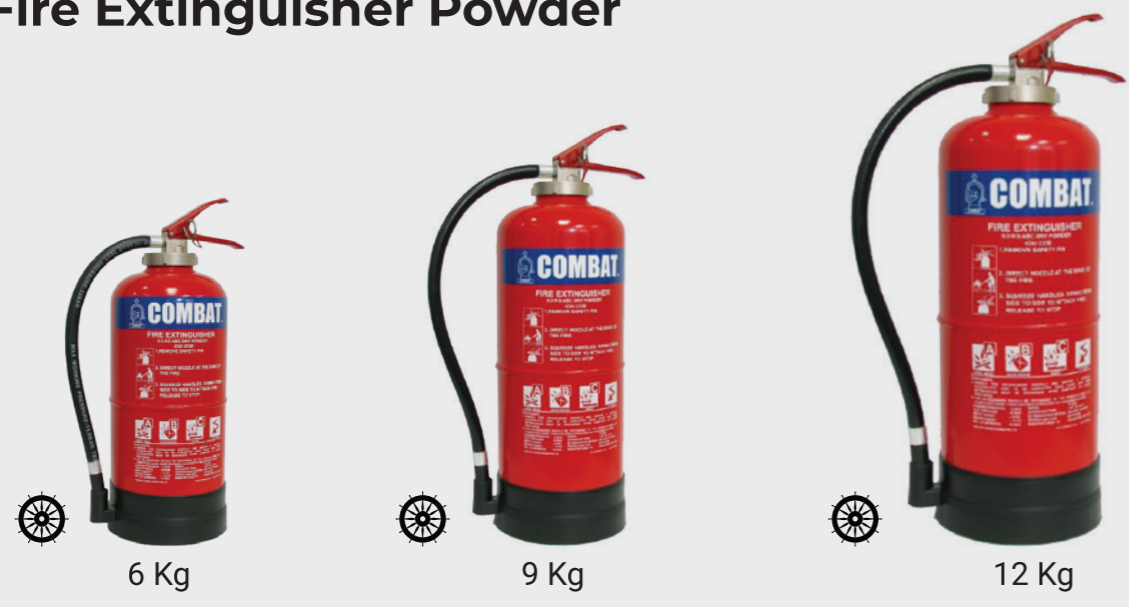

ABC Cartridge Fire Extinguisher COMBAT

Brand	COMBAT (Lingjack)		
Capacity	6 Kg	9 Kg	12 Kg
Extinguishing Medium	40% ABC Dry Chemical Powder		
Propellant Type	110 gram CO ₂	150 gram CO ₂	225 gram CO ₂
Fire Rating	27A, 233B, C	43A, 233B,C	55A,233B,C
Class of Fire	A,B,C		
Discharge Time	18 sec	19.4 sec	25.8 sec
Discharge Range	5 m	7 m	10 m
Working Pressure	10.3 bar	14.6 bar	14 bar
Working Temperature	-20Deg C to +60 Deg C		
Finishing	RAL 3000		
Hose Length	440 mm	530 mm	620 mm
Size	Dia. 181 x 526(H) mm	Dia. 181 x 575(H) mm	Dia. 181 x 640(H) mm
Gross Weight	Approx. 11 kg	Approx. 13.5 kg	Approx. 18.0 kg
One year warranty			



ABC Stored Pressure Fire Extinguisher COMBAT

Brand	COMBAT (Lingjack)		
Capacity	1 Kg	2 Kg	3 Kg
Extinguishing Medium	40% ABC Dry Chemical Powder		
Propellant Type	Nitrogen	Nitrogen	Nitrogen
Fire Rating	5A, 55B, C	13A, 55B, C	13A, 55B, C
Class of Fire	A,B,C		
Discharge Time	9.53 sec	9.66 sec	11.7 sec
Discharge Range	3 m	3 m	3 m
Working Pressure	14 bar		
Working Temperature	-20Deg C to +60 Deg C		
Finishing	RAL 3000		
Size	Dia. 85 x 320(H) mm	Dia. 98 x 455(H) mm	Dia. 115 x 470(H) mm
Gross Weight	Approx. 2.0 kg	Approx. 3.7 kg	Approx. 5.0 kg
One year warranty			





ABC Stored Pressure Fire Extinguisher COMBAT

Brand	COMBAT (Lingjack)			
Capacity	4 Kg	6 Kg	9 Kg	12 Kg
Extinguishing Medium				
Propellant Type	Nitrogen	Nitrogen	Nitrogen	Nitrogen
Fire Rating	21A, 144B, C	34A, 233B, C	43A, 233B, C	55A, 233B, C
Class of Fire				
Discharge Time	16.33 sec	19.37 sec	24.87 sec	25 sec
Discharge Range	5 m	5 m	7 m	7 m
Working Pressure	14 bar			
Working Temperature	-20Deg C to +60 Deg C			
Finishing	RAL 3000			
Size	Dia. 139 x 465(H) mm	Dia. 181 x 495(H) mm	Dia. 181 x 600(H) mm	Dia. 181 x 620(H) mm
Gross Weight	Approx. 6.5 kg	Approx. 9.6 kg	Approx. 13.0 kg	Approx. 16.0 kg
One year warranty				



RUIHUA Dry chemical powder fire extinguisher

Brand	RUIHUA		
Product Code	P1GS	P2GS	P3GS
Capacity	1 Kg	2 Kg	3 Kg
Fire Rating	8A 55B C	13A 89B C	21A 144B C
Operating Pressure	15 bar		
Discharge Time	Approx. 10.5 sec	Approx. 11.6 sec	Approx. 17.3 sec
Dimensions	Dia. 95 x 345(H) mm	Dia. 110 x 435(H) mm	Dia. 130 x 440(H) mm
Overall Mass	Approx. 2.0 kg	Approx. 3.4 kg	Approx. 5.0 kg

- Deep drawn steel cylinder with welded base and robust skirt.
- Powder coated with UV resistant paint finish, giving extra resistance to standard corrosive environments together with dents and wears associated with normal fire extinguisher use.
- EPDM type UV resistant discharge hose with dust cap.
- Zinc plated brass valve with pressure indicator.
- 316 Stainless steel handles and levers – suitable for aggressive environments.
- Non-Aluminium Hose Ferrules on 4.5kg & 9.0kg required for underground use.
- 316 Stainless steel hose retaining clip and bands on 2.5kg, 4.5kg & 9.0kg models
- Sturdy solid stainless steel hanging bracket, ideal for aggressive environments.
- A rugged epoxy coated metal vehicle bracket comes with 1.0kg, 2.0kg & 2.5kg models. 2.5kg model comes with wall bracket for internal installation.
- Aluminium inspection tag and ring (to be removed for underground coal mines).
- Fire extinguishers have been fire tested for the use in A, B & E Class fires.



RUIHUA Dry chemical powder fire extinguisher

Brand	RUIHUA			
Product Code:	P4GS	P6GS	P9GS	P12GS
Capacity	4	6	9	12
Fire Rating	27A 233B C	43A 233B C	55A 233B C	55A 233B C
Operating Pressure	15bar			
Discharge Time (approx)	17.6 sec	24.3 sec	28.3 sec	37.3 sec
Dimensions (height x diameter)	445 x 148 mm	542 x 158 mm	585 x 193 mm	605 x 198 mm
Overall Mass (approx)	6.5 kg	9.5 kg	13.7 kg	17.1kg



Fire Extinguisher Foam



9L Foam Cartridge Fire Extinguisher COMBAT

Brand	COMBAT (Lingjack)
Capacity	9 ltr
Extinguishing Medium	Foam
Propellant Type	75 gram CO2
Fire Rating	34A, 233B
Class of Fire	A,B
Discharge Time	35 sec
Discharge Range	7 m
Working Pressure	14 bar
Working Temperature	5 Deg C to 60 Deg C
Finishing	RAL 3000
Hose Length	530 mm
Size	Dia. 181 x 640(H) mm
Gross Weigh	13.5 kg



6 Ltr



9 Ltr

Foam Stored Pressure Fire Extinguisher COMBAT

Brand	COMBAT (Lingjack)	
Capacity	6 ltr	9 ltr
Extinguishing Medium	Foam	
Propellant Type	Nitrogen	
Fire Rating	8A, 113B	34A, 233B
Class of Fire	A,B	A,B
Discharge Time	21.3 sec	25.7 sec
Discharge Range	7 m	
Working Pressure	14 bar	
Working Temperature	5 Deg C to 60 Deg C	
Finishing	RAL 3000	
Hose Length	295 mm	530 mm
Size	Dia. 181 x 495(H) mm	Dia. 181 x 600(H) mm
Gross Weigh	Approx. 10.0 kg	Approx. 13.6 kg



RUIHUA Foam Fire Extinguisher

Brand	RUIHUA		
Product Code	S2Eco	S6Eco	S9Eco
Capacity	2 Ltr	6 Ltr	9 Ltr
Fire Rating	8A 55B	21A 183B	27A 233B
Operating Pressure	12 bar		
Discharge Time	Approx. 17.2 sec	Approx. 55.7 sec	Approx. 80.3 sec
Dimensions	Dia. 115 x 420(H) mm	Dia. 169 x 540(H) mm	Dia. 193 x 585(H) mm
Overall Mass	Approx. 3.8 kg	Approx. 9.6 kg	Approx. 14.2 kg

- Stainless steel cylinder.
- Filled and charged ready to use.
- Powder coated with UV resistant paint finish.
- Stainless steel handles and levers – suitable for aggressive environments.
- Heavy duty zinc plated brass valve with easy to read pressure indicator.
- Wall hanging bracket.
- Australian Standards Aluminium Inspection Tag supplied and fitted to extinguisher.
- Schrader valve, 45 degrees from horizontal for easier recharging.
- Presto AFFF Foam is a fluorine free, Environmentally friendly foam.
- Fire extinguishers have been fire tested for their use in A Class fires. Rating is an indication of the level of fire testing achieved. All testing is carried out by fire professionals.

Mobile Fire Extinguisher



ABC Cartridge Type Mobile Fire Extinguisher COMBAT

Brand	COMBAT (Lingjack)				
Capacity	25 kg	50 Kg	75 Kg	100 Kg	150 Kg
Extinguishing Medium	ABC 70%				
Propellant Type	Nitrogen	1.5kg CO ₂	3.0kg CO ₂	3.5kg CO ₂	4.0kg CO ₂
Fire Rating	55A, II B (275 B), C		55A, IV B (317 B), C		
Class of Fire	A, B, C				
Discharge Time	32 secs	70 sec	110 secs	170 Sec	200 secs
Discharge Range	10 m				
Working Pressure	14 bar				
Working Temperature	-20Deg C to 60 Deg C				
Finishing	RAL 3001				
Hose Length	3/4" x 6 meters (option up to 12 meter)				
Size (LxDxH) (mm)	440x400x930	530x550x994	580x600x1180	660x690x1120	650x710x1320
Wheel Size	Dia. 406mm x 50mm				
Gross Weight	49 Kg	96 Kg	137.0 Kg	171.0 Kg	230.5 kg



50 Kg

100 Kg

135 Kg

Foam Cartridge Type Mobile Fire Extinguisher COMBAT

Brand	COMBAT (Lingjack)		
Capacity	50 Ltr	100 Ltr	135 Ltr
Extinguishing Medium	SC-1 Foam		
Propellant Type	1.0kg CO ₂	2.0kg CO ₂	3.0kg CO ₂
Fire Rating	34A,IV B (317 B)		
Class of Fire	A, B		
Discharge Time	75 secs	150 sec	110 secs
Discharge Range	10 m		
Working Temperature	5 Deg C to 60 Deg C		
Finishing	RAL 3000		
Hose Length	3/4" x 6 meters (option up to 12 meter)		
Size (LxDxH) (mm)	530x550x995 mm	660x690x1120	650x710x1320 mm
Wheel Size	Dia. 406 x 50mm		
Gross Weight	95 Kg	171.0 Kg	205.0 Kg



25 Kg

50 Kg

Foam Stored Pressure Mobile Fire Extinguisher COMBAT

Brand	COMBAT (Lingjack)	
Capacity	25 Ltr	50 Ltr
Extinguishing Medium	SC-1 Foam	
Propellant Type	Nitrogen	
Fire Rating	34A, II B (275 B)	
Class of Fire	A, B	
Discharge Time	50 secs	100 sec
Discharge Range	10 m	
Working Temperature	5 Deg C to 60 Deg C	
Finishing	RAL 3000	
Hose Length	3/4" x 6 meters (option up to 12 meter)	
Size (LxDxH) (mm)	440x400x930 mm	530x550x995
Wheel Size	Dia. 406 x 50mm	
Gross Weight	49.0 Kg	89.0 Kg

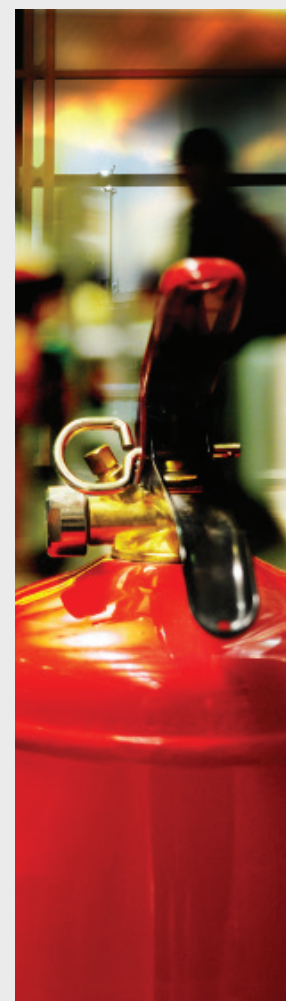



20 Kg



30 Kg

CO₂ Stored Pressure Fire Extinguisher COMBAT

Brand	COMBAT (Lingjack)	
Capacity	20 Kg	30 Kg
Extinguishing Medium	CO ₂	
Propellant Type	CO ₂	
Fire Rating	89 B, C	113 B, C
Class of Fire	B, C	
Discharge Time	44 secs	64 sec
Discharge Range	10 m	
Working Temperature	-20Deg C to 60 Deg C	
Finishing	RAL 3000	
Hose Length	3/8" x 6 meters (option up to 12 meter)	
Size (LxDxH) (mm)	590x640x1470 mm	590x640x1470
Wheel Size	Dia. 406 x 50mm	
Gross Weight	90.0 Kg	100.0 Kg



Code	P25TG
Capacity	25 Kg



Code	P50TG
Capacity	50 Kg

RUIHUA Mobile Fire Extinguisher

Brand	RUIHUA	
Product Code	P25TG	P50TG
Capacity	25 Kg	50 Kg
Operating Pressure	15 bar	
Fire Rating	34A, IVB, C	
Discharge Time	Approx. 44.74 sec	Approx. 37.94 sec
Dimensions	Dia. 810 x 980(H) mm	Dia. 700 x 1050(H) mm
Overall Mass	Approx. 46.7 kg	Approx. 87 kg

- Deep drawn steel cylinder with welded base and robust skirt..
- Powder coated with UV resistant paint finish, giving extra resistance to standard corrosive environments together with dents and wears associated with normal fire extinguisher use.
- EPDM type UV resistant discharge hose with dust cap.
- Zinc plated brass valve with pressure indicator.
- 316 Stainless steel handles and levers – suitable for aggressive environments.
- Non-Aluminium Hose Ferrules on 4.5kg & 9.0kg required for underground use.
- 316 Stainless steel hose retaining clip and bands on 2.5kg, 4.5kg & 9.0kg models.
- Sturdy solid stainless steel hanging bracket, ideal for aggressive environments.
- A rugged epoxy coated metal vehicle bracket comes with 1.0kg, 2.0kg & 2.5kg models. 2.5kg model comes with wall bracket for internal installation.
- Aluminium inspection tag and ring (to be removed for underground coal mines).
- Fire extinguishers have been fire tested for the use in A, B & E Class fires.



OTHER DEVICES

Brass



- Type: MACHINO
- Size: 40/50/65 mm
- Origin: China



- Type: NAKAJIMA
- Size: 40/50/65 mm
- Origin: China



- Type: JOHN MORRIS
- Size: 40/50/65 mm
- Origin: China



- Type: STORZ
- Size: 40/50/65 mm
- Origin: China



- Type: USA PIN (ANTI TYPE)
- Size: 40/50/65 mm
- Origin: China



- Type: GOST
- Size: 40/50/65 mm
- Origin: China

Fire Steering



Fire Steering D65 (type A)

- This product is made of aluminum alloy
- The surface of the product is oxidized and polished
- Inlet diameter: D65 mm
- Nozzle diameter: 16±0.2 mm
- Made in Vietnam



Fire Steering D50 (type B)

- This product is made of aluminum alloy
- The surface of the product is oxidized and polished
- Inlet diameter: D50 mm
- Nozzle diameter: 13±0.2 mm
- Made in Vietnam





• Type: John Morris/Spray
• Diameter.: D40/D50/D65



• Type: Nakajima Jet/Spray
• Diameter.: D40/D50/D65



• Type: John Morris Straight Stream
• Diameter.: D40/D50/D65



• Type: Machino Jet/Spray
• Diameter.: D40/D50/D65



• Type: Storz
• Diameter.: D40/D50/D65

Fire Hose



Fire Hose Japan
• Size: D65x20 mm



Fire Hose Germany
• Size: D50x20 mm



Fire Hose Korean
• Size: D65x20 mm

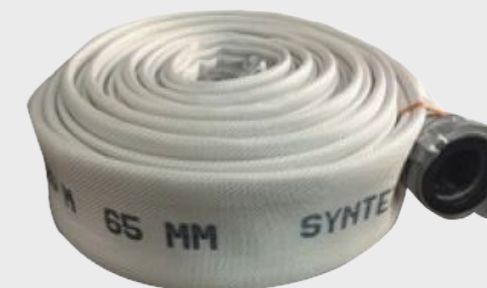

Fire Hose Korean
• Size: D65x30 mm

Pit Hydrant



Pit Hydrant Nakajima

Pit Hydrant Storz

Fire Blanket



- Size: 1 x 1m; 1.2 x 1.2 m; 1.5 x 1.8 m;...
- Materials: 100% fiberglass insulation, non-toxic
- Depth: 0.43 mm
- Color: White
- Temperature resistance: >550oC
- Weight: 430/m₂
- Package: Plastic bag or plastic box



Thermal Protective Aid



Code | TPA-I

- Material: composite of aluminium foil and oxford fiber
- Size: 2000*980mm
- Thermal conductivity: ≤7800W/(cm2.k)
- Certificate: CCS/EC



Code | TPA-II

- Material: Aliminium foil polyester
- Size: 2000*640mm
- Certificate: EC

Test Lamp



Code | T-229/4P

Universal T-229/4P UV/IR Flame Detector Test Lamp

- Universal Flame Detector Test lamp
- Selectable Continuous mode for UV and Pulsing mode for IR and UV/IR
- UV detector check up to 8 meters (26 ft)
- IR and UV/IR Flame Detector check up to 4 meters (13 ft)
- Universal charger 100-240 Vac with pins for US, EU, GB en AU
- Carrying Case (always included in the Americas and optional in the Rest of the World)



Mooring handling



Supertuf PP 4 Strand ropes

- Materials: PolyPropylene
- Diameter: 8mm
- Perimeter: 25.4 mm
- Weight: 3.3 kg/100m
- Traction: 750 KgH



TUFLEX ropes

- Materials: Polyester và Polypropylene
- Diameter: 40mm
- Perimeter: 127 mm
- Weight: 195 Kg/220m
- Traction: 30700 KgH



Supertuf Plus PP 8 Strand ropes

- Materials: Polypropylene
- Diameter: 40mm
- Perimeter: 127 mm
- Weight: 158 Kg/220m
- Traction: 32200 KgH



Manila ropes

- Diameter: 18/20/22/34/44/48 mm
- Wire Length: 200m
- Origin: Indian



Wheelhouse equipment



Bell



Rescue flashlight



Marine electric horns



Clinometer



Maritime binoculars



Mariner's Compass



Barometer



Chart Maintenance Pen



Lalizas compass



Ritchie compass



Marine Slave Clock

GMDSS equipments



ICOM walkie-talkie



IC-M304 walkie-talkie



JMC F-2000 sounder



Navtex JMC NT-900 Weather receiver



AIS MA-500TR



GPS AIS FURUNO GP-39



Wind speed meters Tenmars TM 402



Maritime Radar FURUNO MODEL 1835



Reflective equipment Radar SRC CRT 100





AIS
XINUO XF-607B



Hondax
SONAR FURUNO GP-39



NAVTEX receiver

Supplies



Food ration



Fresh water



First aid kit



Navigation charts